

# Outdoor Lifestyle

**fast**

# Outdoor Lifestyle

**fast**

# Ninfea

Design Alberto Lievore







4621 Ninfea Sideboard - cfg. 11  
 7621 Ria Soft Armchair - cfg. 11PTBU  
 3214A Mosaiko Small table (50 x 56 x h 45cm) - cfg. 11



- 57R22G AllSize  
Table (221 x 101 x h 74cm) - cfg. 13GNV
- 7601 Ria Dining armchair - cfg. 13C03
- 7602 Ria Dining armchair - cfg. 13C03
- 634 Seat cushion - cfg. ERWI
- 4622 Ninfea sideboard - cfg. 13
- 7623 Ria  
Soft 3-seater sofa - cfg. 21ERLG
- 613 Deco cushion - cfg. ERWI
- 612 Deco cushion - cfg. CIGN
- 640 Deco cushion - cfg. ERWI
- 7622 Ria Soft  
2-seater sofa - cfg. 21ERLG
- 56R16G AllSize  
Low table (160 x 90 x h 38cm) - cfg. 21GGC









4611 Ninfea Sideboard - cfg. 14

# Ninfea

Design Alberto Lievore







# Frames and fabrics

## Finiture · Frames

### Alluminio Verniciato · Painted Aluminium



1 Bianco · White

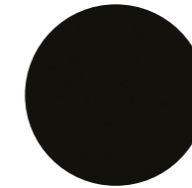

2 Nero · Black



9 Grigio Metallo ·  
Metallic Grey

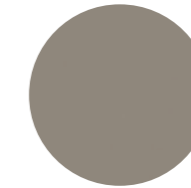

11 Oro Perlato ·  
Pearly Gold

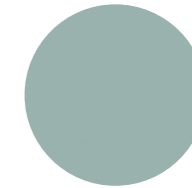

13 Azzurro Pastello ·  
Light Blue



14 Grigio Polvere ·  
Powder Grey



17 Bianco Crema ·  
Creamy White



19 Tè Verde · Green Tea



20 Blu Notte · Dark Blue

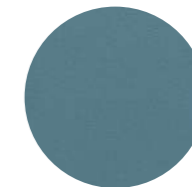

21 Blu Petrolio · Blue Teal



22 Iron Grey

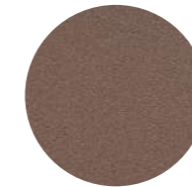

23 Maracuja

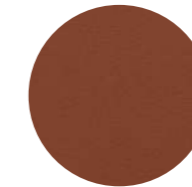

24 Terracotta · Terracotta



25 Verde Bosco · Dark Green

### Alluminio Puntinato · Speckled Aluminium



1S Antracite · Anthracite

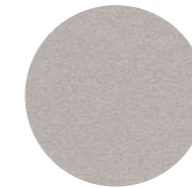

2S Grigio · Grey

### Gres · Stoneware



GNV Neve · Snow



GNO Nocciola · Hazel



GNT Notte · Night

RANGE 1

## Finiture · Frames

RANGE 2



GCR Corten



GFU Grigio Fumé · Smoky Grey



GGC Grigio Chiaro · Light Grey

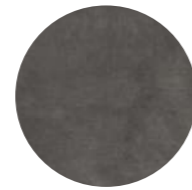

GCM Cemento · Cement



GPL Polar



GDO Dove



GMN Midnight

### Naturall



W03 Naturall Chiaro · Light Naturall

### HPL

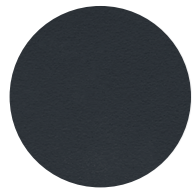

AN Antracite · Anthracite



BI Bianco · White

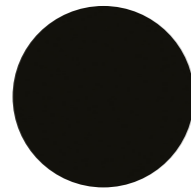

NE Nero · Black



TA Taupe · Dove-Grey

### Wood



L01 Iroko



L02 Rovere sbiancato  
Bleached oak

## Tessuti · Fabrics

RANGE 1

### Solids



SBI Bianco · White

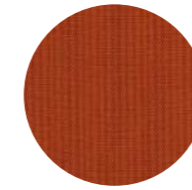

SCO Colorado

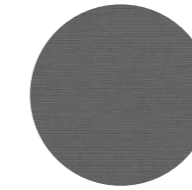

SGR Grigio · Grey



SLN Lino · Linen

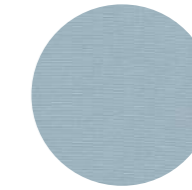

SMI Mineral

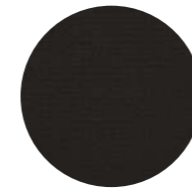

SNE Nero · Black



SPE Perla · Pearl



STA Taupe · Dove Grey

### Natté



NACA Canvas · Canvas



NANO Nocciola · Hazel

### Liso

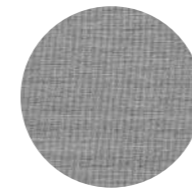

LCE Cenere · Ash

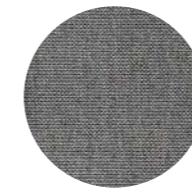

LGF Grafite · Graphite



LSA Salvia · Sage

Tessuti · Fabrics

RANGE 2

Bruma (agona)

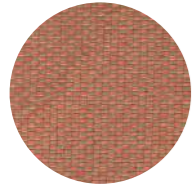

BRCR Coral

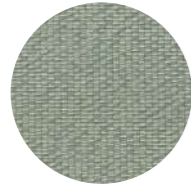

BRLQ Liqueur

Panama (agona)



PNME Menta

Lopi (umbrella)



LOCH Charcoal



LOMR Marble



LOSB Sabbia · Sand

Trama



TRMU Mud

RANGE 3

Atrium kvadrat

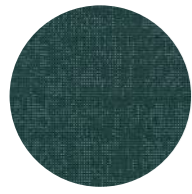

ATAM Amazonia

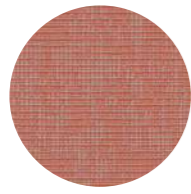

ATAP Apricot

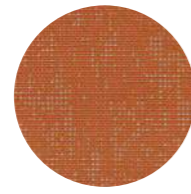

ATCY Canyon



ATDS Deep Sea



ATLI Lime



ATPR Pergamena

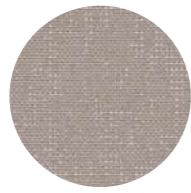

ATSV Savana



ATST Storm

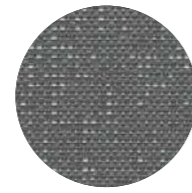

ATVO Volcano

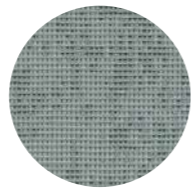

ATWM White Musk

Cima **MARIAFLORA**  
ITALIAN LUXURY PERFORMANCE FABRICS



CIBL Blue



CIGN Green

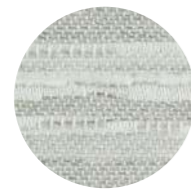

CIGR Grey



CIVI Violet

Tessuti · Fabrics

RANGE 3

Erfoud **MARIAFLORA**  
ITALIAN LUXURY PERFORMANCE FABRICS

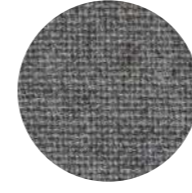

ERCT Corteccia

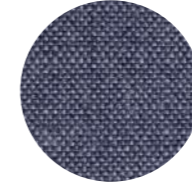

ERDN Denim

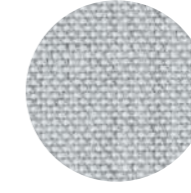

ERIC Iceland

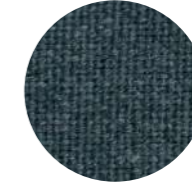

ERLG Lagoon



ERLV Lavander

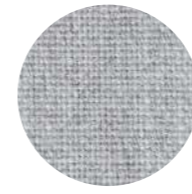

ERMS Mist

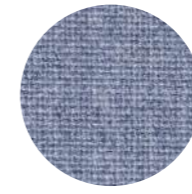

ERRI River

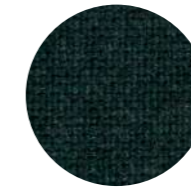

ERSL Selva

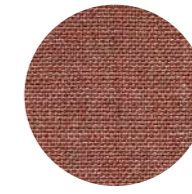

ERSF Starfish

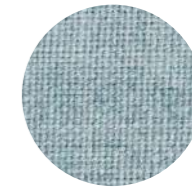

ERWI Willow

Kelso **MARIAFLORA**  
ITALIAN LUXURY PERFORMANCE FABRICS



KEBL Blue

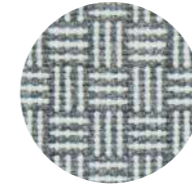

KEDG Dark Grey

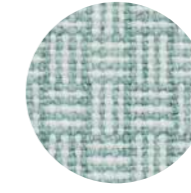

KEGN Green

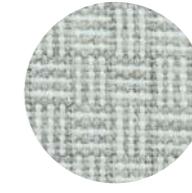

KEGR Grey

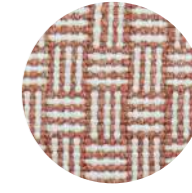

KEPI Pink

Patio kvadrat

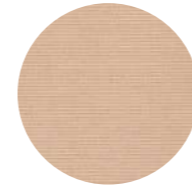

PTBU Blush

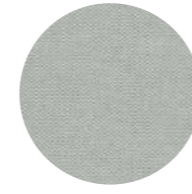

PTPO Polvere · Dust



PTQU Quinoa

Zagora **MARIAFLORA**  
ITALIAN LUXURY PERFORMANCE FABRICS

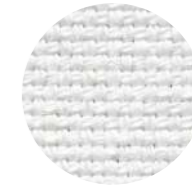

ZACN Cotton

Tessuti · Fabrics

Liso Laminated **(agora)**

RANGE LAMINATED

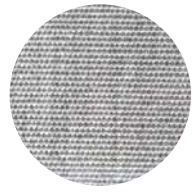

LCEL Cenero · Ash

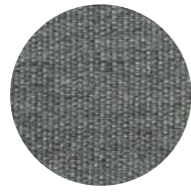

LGFL Grafite · Graphite

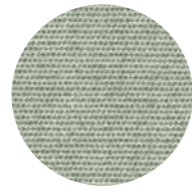

LSAL Salvia · Sage

Solids Laminated **(ombrella)**



SBIL Bianco · White



SCOL Colorado

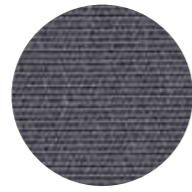

SGRL Grigio · Grey

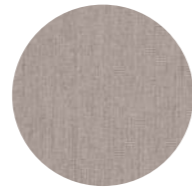

SLNL Lino · Linen

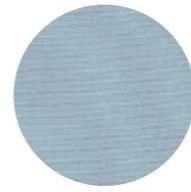

SMIL Mineral



SNEL Nero · Black



SPEL Perla · Pearl



STAL Taupe · Dove Grey

Feltro · Felt



FCL Colonia



FDG Dark Grey



FPN Panna · Cream



FRA Rame · Copper

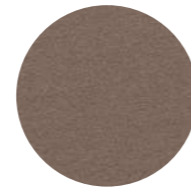

FTA Taupe · Dove Grey

Tessuti · Fabrics

RANGE 1

Batylite



BBI Bianco · White

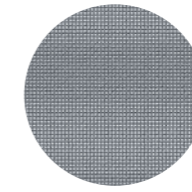

BBR Blu Ardesia · Slate Blue

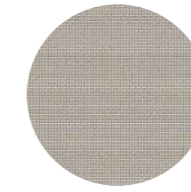

BEC Ecrú

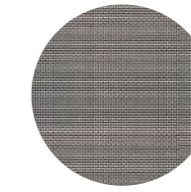

BGR Grigio · Grey

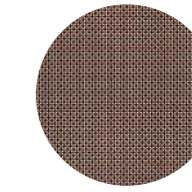

BMA Marrone · Brown

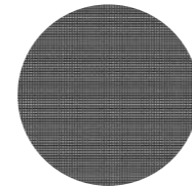

BNE Nero · Black

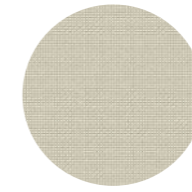

BVE Verde · Green

RANGE 2

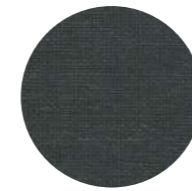

BCB Carbon

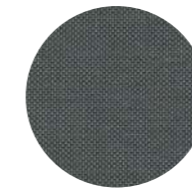

BSI Silver

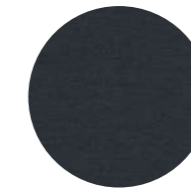

BBL Blue

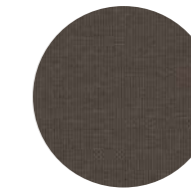

BCA Cacao



BBT Butter



BBE Beige



BSN Sand



BMK Milk



Corde • Ropes



C01 Arizona



C02 Black Sand



C03 Mint



C04 Moon



C05 Rock



C06 Sunset



C07 Ocean

Corde piatte • Flat ropes



F01 Arizona



F02 Black Sand



F03 Mint



F04 Moon

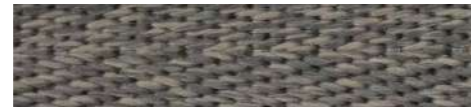

F05 Rock



F07 Ocean

Notes

---

---

---

---

---

---

---

---

---

---

---

---

---

---

---

---

---

---

---

---

---

---

---

---

# Outdoor Lifestyle

## Price List

01/10/2023 – 30/09/2024

IVA ESCLUSA / VAT FREE / OHNE MWST / HORS TVA / SIN IVA

**fast**

**Alluminio verniciato • Painted aluminium • Lackiertes Aluminium • Aluminium verni • Aluminio lacado**

1	Bianco • White • Weiss • Blanc • Blanco
2	Nero • Black • Schwarz • Noir • Negro
9	Grigio Metallo • Metallic Grey • Metallgrau • Gris Métal • Gris Metálico
11	Oro Perlato • Pearly Gold • Taupe • Or Perlé • Oro Perlado
13	Azzurro Pastello • Light Blue • Pastellhellblau • Pastel Bleu • Azul Pastel
14	Grigio Polvere • Powder Grey • Pulvergrau • Gris Poudre • Gris Polvo
17	Bianco Crema • Creamy White • Cremeweiss • Blanc Crème • Blanco Crema
19	Tè Verde • Green Tea • Grüner Tee • Thé Vert • Té Verde
20	Blu Notte • Dark Blue • Dunkelblau • Bleu Nuit • Azul Noche
21	Blu Petrolino • Blue Teal • Öl Blau • Bleu Canard • Azul Petròleo
22	Iron Grey
23	Maracuja
24	Terracotta • Terracotta • Terrakotta • Terre Cuite • Terracota
25	Verde Bosco • Dark Green • Dunkelgrün • Vert Bois • Verde Bosque

**Alluminio puntinato • Speckled aluminium • Gesprenkeltes Aluminium • Aluminium granité • Aluminio moteado**

1S	Antracite • Anthracite • Anthrazit • Anthracite • Antracita
2S	Grigio • Grey • Grau • Gris • Gris

**Gres • Stoneware • Feinsteinzeug • Grès • Gres****Range 1**

GNV	Neve • Snow • Schnee • Neige • Nieve
GNO	Nocciola • Hazel • Haselnuss • Noisette • Avellana
GNT	Notte • Night • Nacht • Nuit • Noche

**Range 2**

GPL	Polar
GDO	Dove
GMN	Midnight
GCR	Corten
GFU	Grigio Fumé • Smoky Grey • Rauchgrau • Gris Fumé • Gris Humo
GGC	Grigio Chiaro • Light Grey • Helles Grau • Gris Clair • Gris Claro
GCM	Cemento • Cement • Zement • Ciment • Cemento

**NaturAll**

W03	Naturall Chiaro • Light Naturall • Helles Naturall • Naturall Clair • Naturall Claro
-----	--

**Wood**

L01	Iroko
L02	Rovere sbiancato • Bleached oak • Gebleichter Eiche • Chêne blanchi • Roble blanqueado

**HPL**

AN	Antracite • Anthracite • Anthrazit • Anthracite • Antracita
BI	Bianco • White • Weiss • Blanc • Blanco
NE	Nero • Black • Schwarz • Noir • Negro
TA	Taupe • Dove-Grey • Taupe • Gris Tourtorelle • Taupe

**Batyline****Range 1**

BBI	Bianco • White • Weiss • Blanc • Blanco
BBR	Blu Ardesia • Slate Blue • Schiefer Blau • Bleu Ardoise • Azul Pizarra
BEC	Ecru
BGR	Grigio • Grey • Grau • Gris • Gris
BMA	Marrone • Brown • Braun • Marron • Marrón
BNE	Nero • Black • Schwarz • Noir • Negro
BVE	Verde • Green • Grün • Vert • Verde

**Range 2**

BCB	Carbon
BSI	Silver
BBL	Blue
BCA	Cacao
BBT	Butter
BBE	Beige
BSN	Sand
BMK	Milk

**Range 1**

**Solids**

SBI Bianco · White · Weiss · Blanc · Blanco  
 SCO Colorado  
 SGR Grigio · Grey · Grau · Gris · Gris  
 SLN Lino · Linen · Leinen · Lin · Lino  
 SMI Mineral  
 SNE Nero · Black · Schwarz · Noir · Negro  
 SPE Perla · Pearl · Hellgrau · Perlé · Perla  
 STA Taupe · Dove-Grey · Taupe · Gris Tourtorelle · Taupe

**Natté**

NACA Canvas · Canvas · Segeltuch · Toile · Tela  
 NANO Nocciola · Hazel · Haselnuss · Noisette · Avellana

**Liso**

LCE Cenere · Ash · Asche · Cendre · Ceniza  
 LGF Grafite · Graphite · Graphit · Graphite · Grafito  
 LSA Salvia · Sage · Salbei · Saugé · Sage

**Range 2**

**Bruma**

BRCR Coral  
 BRLQ Liquen

**Lopi**

LOCH Charcoal  
 LOMR Marble  
 LOSB Sabbia · Sand · Sand · Sable · Arena

**Panama**

PNME Menta

**Trama**

TRMU Mud

**Range 3**

**Atrium**

ATAM Amazzonia  
 ATAP Apricot  
 ATCY Canyon  
 ATDS Deep Sea  
 ATLI Lime  
 ATPR Pergamena  
 ATSV Savana  
 ATST Storm  
 ATVO Volcano  
 ATWM White Musk

**Cima\***

CIBL Blue  
 CIGN Green  
 CIGR Grey  
 CIVI Violet

**Erfoud**

ERCT Cortecchia  
 ERDN Denim  
 ERIC Iceland  
 ERLG Lagoon  
 ERLV Lavander  
 ERMS Mist  
 ERRI River  
 ERS� Selva  
 ERSF Starfish  
 ERWI Willow

**Range 3**

**Kelso**

KEBL Blue  
 KEDG Dark Grey  
 KEGN Green  
 KEGR Grey  
 KEPI Pink

**Patio**

PTBU Blush  
 PTPO Polvere · Dust · Pulver · Poudre · Polvo  
 PTQU Quinoa

**Zagora**

ZACN Cotton

**Range Laminated**

**Liso • Laminated**

LCEL Cenere · Ash · Asche · Cendre · Ceniza  
 LGFL Grafite · Graphite · Graphit · Graphite · Grafito  
 LSAL Salvia · Sage · Salbei · Saugé · Sage

**Solids • Laminated**

SBIL Bianco · White · Weiss · Blanc · Blanco  
 SCOL Colorado  
 SGRL Grigio · Grey · Grau · Gris · Gris  
 SLNL Lino · Linen · Leinen · Lin · Lino  
 SMIL Mineral  
 SNEL Nero · Black · Schwarz · Noir · Negro  
 SPEL Perla · Pearl · Hellgrau · Perlé · Perla  
 STAL Taupe · Dove-Grey · Taupe · Gris Tourtorelle · Taupe

**Feltro • Felt • Filz • Feutre • Fieltro**

FCL Colonia  
 FDG Dark Grey  
 FPN Panna · Cream · Creme · Crème · Crema  
 FRA Rame · Copper · Kupfer · Cuivre · Cobre  
 FTA Taupe · Dove-Grey · Taupe · Gris Tourtorelle · Taupe

**Corde • Ropes • Schnüre • Cordes • Cuerdas**

C01 Arizona  
 C02 Black Sand  
 C03 Mint  
 C04 Moon  
 C05 Rock  
 C06 Sunset  
 C07 Ocean

**Corde piate • Flat ropes • Flache Schnüre  
 Cordes plates • Cuerdas planas**

F01 Arizona  
 F02 Black Sand  
 F03 Mint  
 F04 Moon  
 F05 Rock  
 F07 Ocean

\* Solo per cuscini decorativi e/o accessori  
 Only for deco cushions and/or accessories  
 Nur für Dekokissen und/oder Zubehör  
 Uniquement pour les coussins décoratifs et/ou les accessoires  
 Solo para cojines decorativos y/o accesorios



Impilabile • Stackable • Stapelbar • Empilable • Apilable



Custom (previa valutazione) • Custom (on evaluation) •  
Custom (zur Bewertung) • Custom (sur l'évaluation) •  
Custom (en evaluación)



Peso lordo • Gross weight • Bruttogewicht  
Poids brut • Peso bruto



Custom in altezza • Custom in height • Custom in der Höhe •  
Custom en hauteur • Custom en altura



PCS. Assembled



EPD  
Certificazione ambientale • Environmental product declaration •  
Umweltzertifizierung • Déclaration environnementale •  
Declaración ambiental



DIS. Disassembled



Dimensione e volume • Dimension and volume • Maße und  
Volumen • Dimension et volume • Medida y volumen

# Ninfea

**Design** Alberto Lievore

<sup>IT</sup> Ninfea è la nuova linea di contenitori da esterno di Fast, con piano in finitura antigraffio. Il motivo a incisione delle porte richiama lo stesso linguaggio di astrazione vegetale presente in altri prodotti Fast e questo permette a Ninfea di integrarsi armoniosamente in tutte le altre collezioni. Oltre alla funzione di contenitore, Ninfea presenta un forte valore arredativo come separatore di spazi e situazioni.

Si aggiunge alla collezione il nuovo serving cart, introducendo una possibilità in più per arredare gli spazi esterni all'insegna della funzionalità e della convivialità. Il carrellino Ninfea ha struttura in alluminio verniciato, estruso, pressofuso e laminato con piano tondo in legno richiudibile e a ribalta.

<sup>EN</sup> Ninfea is the new line of Fast outdoor containers, with a scratch-resistant finish top. The engraved pattern of the doors recalls the same plant-based theme as other Fast products, a choice made for aesthetic consistency which makes Ninfea compatible with all the other collections. Aside from its function as container, Ninfea has a strong furnishing value as separator of spaces and situations.

The new serving cart enriches the collection, introducing an extra possibility for furnishing outdoor spaces in the name of functionality and conviviality. The Ninfea serving cart has a painted, extruded, die-cast and laminated aluminum frame with a round, folding top in wood.

# Ninfea

4611

 45 kg  1 ASS.  cm 104 x 106 x 63 m<sup>3</sup> 0,689

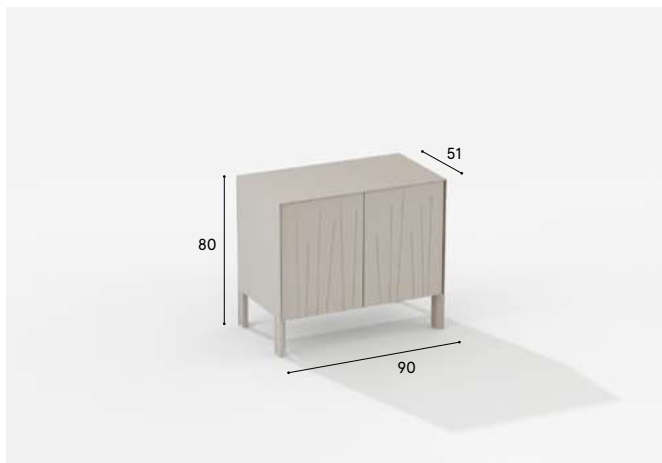

IT Madia in alluminio verniciato  
EN Sideboard in painted aluminium  
DE Anrichte aus lackiertem Aluminium  
FR Buffet en aluminium verni  
ES Aparador en aluminio lacado

**Painted alu**

**Price**

ALL COLOURS

€ 2.855

4612

 47,5 kg  1 ASS.  cm 104 x 106 x 63 m<sup>3</sup> 0,689

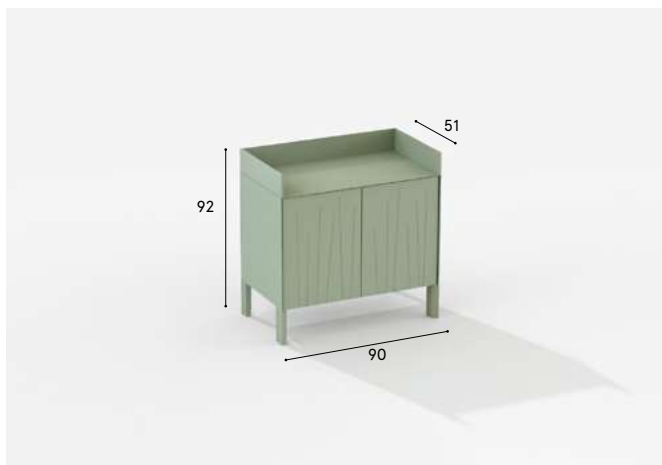

IT Madia in alluminio verniciato con sponda rialzata  
EN Sideboard in painted aluminium with raised edge  
DE Anrichte aus lackiertem Aluminium mit erhöhter Kante  
FR Buffet en aluminium verni avec bord relevé  
ES Aparador en aluminio lacado con borde levantado

**Painted alu**

**Price**

ALL COLOURS

€ 3.091

4621

 75 kg  1 ASS.  cm 193 x 106 x 63 m<sup>3</sup> 1,278

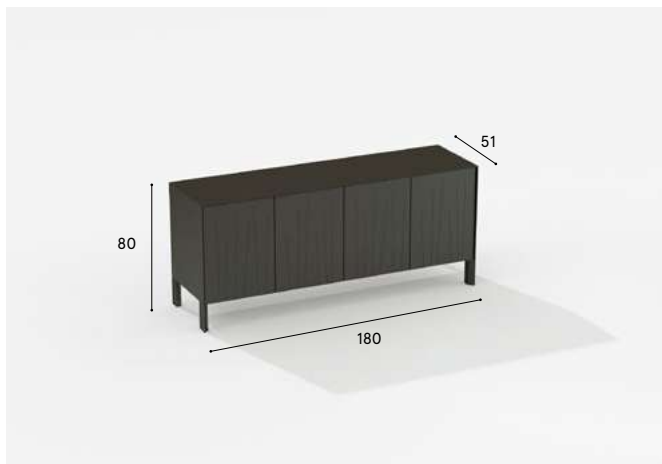

IT Madia in alluminio verniciato  
EN Sideboard in painted aluminium  
DE Anrichte aus lackiertem Aluminium  
FR Buffet en aluminium verni  
ES Aparador en aluminio lacado

**Painted alu**

**Price**

ALL COLOURS

€ 4.516

# Ninfea

**4622**

 78 kg  1 ASS.  cm 193 x 106 x 63 m<sup>3</sup> 1,278



IT Madia in alluminio verniciato con sponda rialzata  
 EN Sideboard in painted aluminium with raised edge  
 DE Anrichte aus lackiertem Aluminium mit erhöhter Kante  
 FR Buffet en aluminium verni avec bord relevé  
 ES Aparador en aluminio lacado con borde levantado

**Painted alu**

**Price**

ALL COLOURS

€ 4.873

**4632**

 28 kg  1 ASS.  cm 95 x 95 x 95 m<sup>3</sup> 0,857

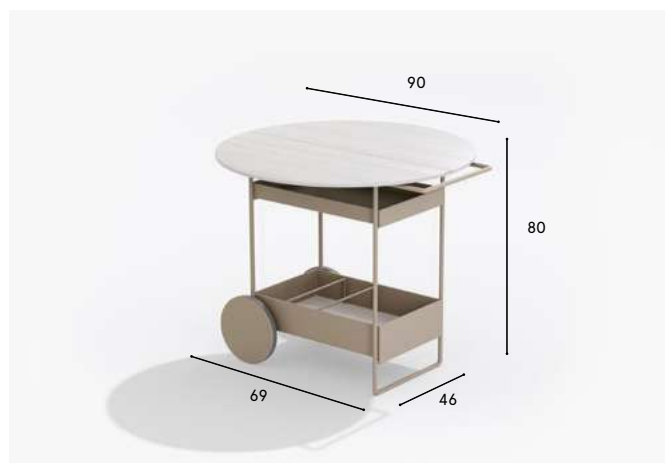

IT Servicing cart con piano in legno richiudibile e a ribalta  
 EN Serving cart with folding top in wood  
 DE Servierwagen mit klappbarer Tischplatte aus Holz  
 FR Chariot de service avec plateau rabattable en bois  
 ES Carro de servicio con tapa abatible en madera

**Painted alu**

**Wood**

**Price**

ALL COLOURS

· ALL WOODS

€ 1.950