

U

UNOSIDER



Feel

The Shadow Experience

Unosider ha un'anima solida e rigorosa fatta di ferro e metallo e una più morbida e leggera fatta di tessuti e decori, una componente di precisione e tecnica e una invece più romantica e visionaria.

La nostra più grande capacità è quella di combinare elementi apparentemente in contrasto in uno scambio attivo e proficuo che crea un valore totalmente nuovo.

Da oltre 25 anni lavoriamo per condividere la nostra visione degli spazi esterni e costruiamo strutture che creano nuovi ambienti e nuove esperienze.

La nostra mission è porre al centro dell'attenzione i desideri e le necessità del cliente e "cucire per lui un abito perfetto realizzato con i migliori materiali".

Unosider has a solid and rigorous soul made of iron and metals and a softer and lighter one made of fabrics and decorations, a precise and technical side and a more romantic and visionary one.

Our greatest ability is to combine seemingly conflicting elements in an active and successful exchange that creates a whole new value.

For over 25 years we have been working to share our vision of outdoor space and build structures that shape new places and experiences.

Our mission is to focus our attention on the wishes and needs of the customer and "to sew a perfect dress made from the finest materials for him".





NOVECENTO

PERGOLA ADDOSSATA WALL-MOUNTED PERGOLA

Morbidezza delle linee ed eleganza delle proporzioni per un ideale e naturale prolungamento della casa. Una protagonista indiscussa della nostra collezione da progettare nelle sue misure standard o adattare alla vostra abitazione per un risultato estetico perfetto. Possibilità di chiudere tutti i lati tramite teli in tessuto o PVC liscio o finestrato per uno spazio riparato in tutte le stagioni.

*A pergola with soft and elegant lines for the perfect house extension.
A beautiful, functional structure which is undisputed star of our collection and is built to fit its home.
All sides can be closed if you choose creating a structure for all seasons with curtains in plain PVC or curtains with windows.*



Misure standard: da 3×2,5 metri a 4×5 metri
+ estensioni
Realizzabile su misura
Scheda tecnica pag 134

*Standard size: from 3×2.5 to 4×5 meters +
extensions
Custom size available
Technical sheets page 134*

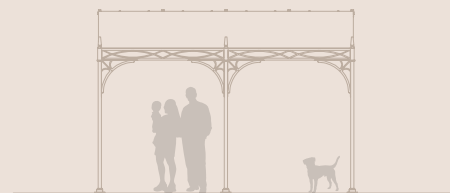



TRAVE LATERALE SIDE BEAM

Possibilità di inserire trave decorata laterale, anche con tamponamento in PVC. Opzionale.

Optional decorated side beam, which is also available with a PVC fabric valance.



TENDE LATERALI IN ACRILICO ACRYLIC FABRIC SIDE CURTAINS

Possibilità di inserire tende laterali in acrilico, complete di cerniera di chiusura.

Side curtains are available in acrylic fabric with zipper closures and a fastening system along the pillars.





PERGOLA NOVECENTO

OPZIONI COLORE

Struttura:

anthracite
tundra
taupe
mars
brown
black
white 9010
oyster white 1013
satin

Telo di copertura:

FLEXLIGHT CLASSIC 602

6285-341 champagne
6285-102 bianco

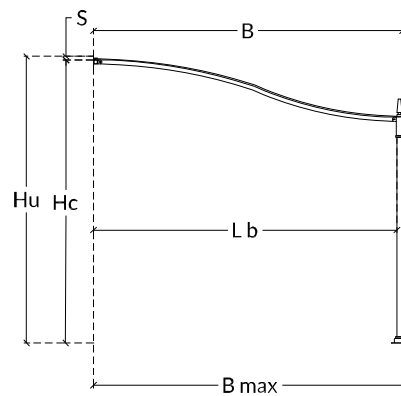
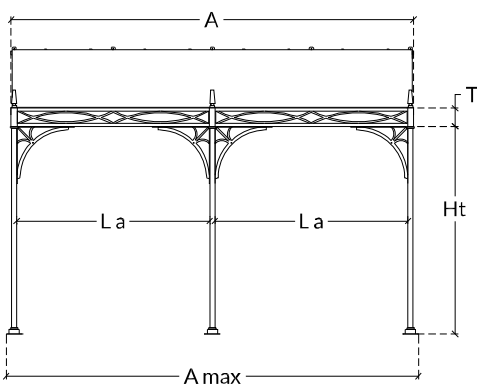
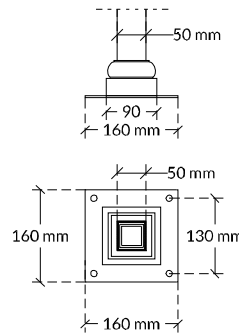
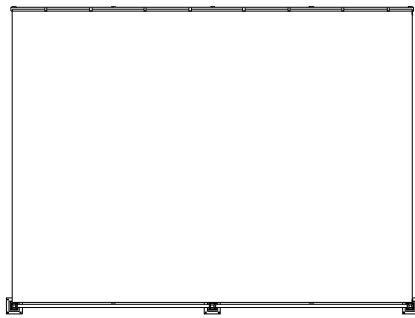

INFORMAZIONI TECNICHE

- sezione pilastro 50x50x1,5 mm
 - sezione trave 180x30 mm sp 1,5 mm
 - sezione spioventi 40x30x2 mm
 - dimensione massima 400x500 cm
 - possibilità di realizzazione su misura
 - profili in acciaio lavorato con trattamento di zincatura a caldo
 - verniciatura a polveri epossidiche a base di resina poliesteri, resistente ai raggi UV
 - possibilità di personalizzazione della verniciatura (con riferimento alla cartella colori RAL) previa approvazione dell'ufficio tecnico
 - telo di copertura standard in PVC Flexlight classic 602, termosaldato, ignifugo classe 2/UNI9177, in colore champagne o bianco
- * i modelli standard 300x500, 350x500 e 400x500 cm differiscono per la dimensione degli spioventi (60x30x3mm)

MISURE STANDARD

cm	300 x 250	300 x 300	300 x 350	300 x 400	300 x 500*	350 x 250	350 x 300	350 x 350	350 x 400	350 x 500*	400 x 250	400 x 300	400 x 350	400 x 400	400 x 500*
A	300	300	300	300	300	350	350	350	350	350	400	400	400	400	400
B	250	300	350	400	500	250	300	350	400	500	250	300	350	400	500
La	142	142	142	142	142	167	167	167	167	167	191	191	191	191	191
Lb	245	295	345	395	495	245	295	345	395	495	245	295	345	395	495
Amax	310	310	310	310	310	360	360	360	360	360	410	410	410	410	410
Bmax	255	305	355	405	505	255	305	355	405	505	255	305	355	405	505
T	18	18	18	18	18	18	18	18	18	18	18	18	18	18	18
Ht	206	206	206	206	206	206	206	206	206	206	206	206	206	206	206
S	4	4	4	4	4	4	4	4	4	4	4	4	4	4	4
Hc	270	280	290	300	330	270	280	290	300	330	270	280	290	300	330
Hu	274	284	294	304	334	274	284	294	304	334	274	284	294	304	334

PERGOLA NOVECENTO

PREZZI STRUTTURA BASE

MISURA (cm) AxB	anthracite	tundra taupe mars brown black	white 9010 oyster white1013 satin
300x250			
300x300			
300x350			
300x400			
300x500			
350x250			
350x300			
350x350			
350x400			
350x500			
400x250			
400x300			
400x350			
400x400			
400x500			

PREZZI ESTENSIONI

MISURA (cm) AxB	anthracite	tundra taupe mars brown black	white 9010 oyster white1013 satin
147x250			
147x300			
147x350			
147x400			
147x500			
172x250			
172x300			
172x350			
172x400			
172x500			
197x250			
197x300			
197x350			
197x400			
197x500			

I prezzi indicati, includono:

- struttura in acciaio lavorato verniciata
- telo di copertura in PVC Flexlight classic 602 champagne (bianco su richiesta, prezzo invariato)

NB: colorazione teli e strutture fuori standard, vedi pag. 9
NB: condizioni di trasporto a pag. 9
NB: prezzo per misura fuori standard a preventivo

MANTOVANA IN PVC

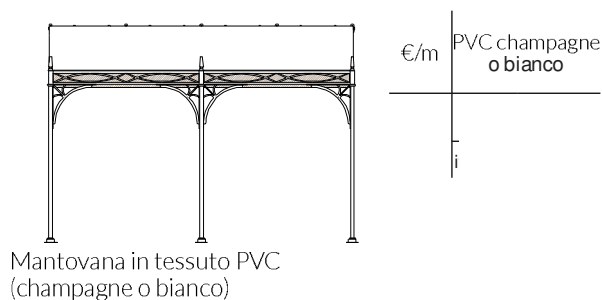

TETTUCCIO DI PROTEZIONE

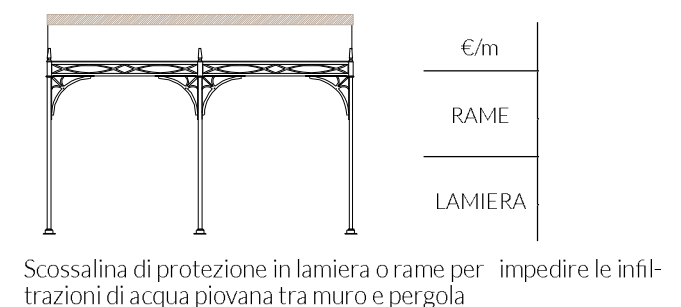

ACCESSORI PERGOLA NOVECENTO

TRAVE LATERALE DECORATO (SENZA TELO)

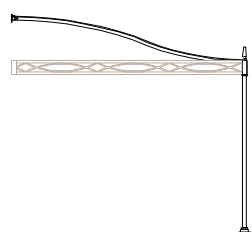

MISURA (cm) B	anthracite	tundra taupe mars brown black	white 9010 oyster white1013 satin
250			
300			
350			
400			
500			

Trave laterale con decoro disponibile nei colori della struttura

NB: non installabile su pergole esistenti
NB: il tappo viene fornito smontato

TRAVE LATERALE DECORATO CON TELO IN PVC

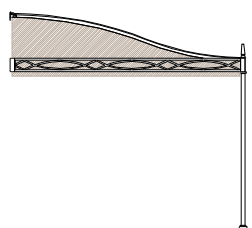

MISURA (cm) B	anthracite	tundra taupe mars brown black	white 9010 oyster white1013 satin
250			
300			
350			
400			
500			

Trave laterale con decoro disponibile nei colori della struttura completo di telo di copertura inPVC Flexlight classic 602 champagne (bianco su richiesta, prezzo invariato)

NB: non installabile su pergole esistenti
NB: il tappo viene fornito smontato

TRAVE LATERALE SEMPLICE (SENZA TELO)

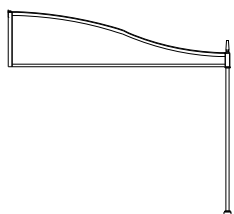

MISURA (cm) B	anthracite	tundra taupe mars brown black	white 9010 oyster white1013 satin
250			
300			
350			
400			
500			

Trave laterale con decoro disponibile nei colori della struttura

NB: installabile su pergole esistenti
NB: il tappo viene fornito smontato

ACCESSORI PERGOLA NOVECENTO

TRAVE LATERALE SEMPLICE CON TELO IN PVC

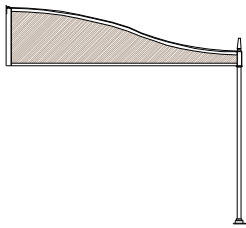

MISURA (cm) B	anthracite	tundra taupe mars brown black	white 9010 oyster white1013 satin
250			
300			
350			
400			
500			

Trave laterale con decoro disponibile nei colori della struttura completo di telo di copertura in PVC Flexlight classic 602 champagne (bianco su richiesta, prezzo invariato)

NB: installabile su pergole esistenti
NB: PVC da sagomare e tagliare in opera in caso di pergola esistente
NB: il tappo viene fornito smontato

ASTA PER TENDE

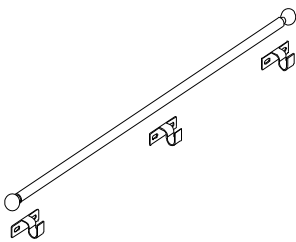

MISURA (cm) LATO	anthracite	tundra taupe mars brown black	white 9010 oyster white1013 satin
147			
172			
197			
250			
300			
350			
400			
500			

Aste singole per il montaggio di tende decorative e laterali

TENDE DECORATIVE IN ACRILICO

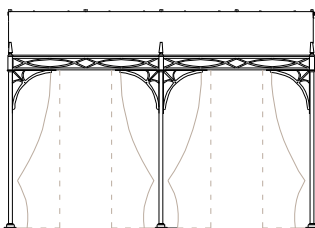

MISURA UNICA	PROGAR
ANGOLARE	
MEZZO	

Singole tende ornamentali in acrilico Progar per decorazione della struttura. Disponibili in versione angolare o solo fronte (mezza tenda angolare)

NB: aggiungere aste per tende

NB: per i colori disponibili vedi pag. 6

ACCESSORI PERGOLA **NOVECENTO**

TENDE LATERALI IN ACRILICO

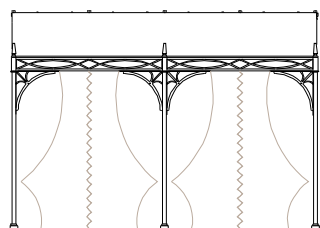

MISURA (cm) LATO	PROGAR
147	
172	
197	
250	
300	
350	
400	
500	

Tenda laterale in tessuto acrilico con cerniera di chiusura centrale. Sistema di scorrimento con passanti in tessuto acrilico (cuciti).

NB: prezzo per singola campata

NB: aggiungere aste per tende

NB: per i colori disponibili vedi pag. 6

NB: le confezioni dei teli laterali possono avere cuciture asimmetriche

TENDE LATERALI IN PVC

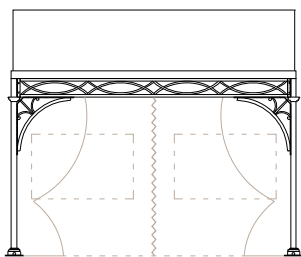

MISURA (cm) LATO	PVC FLEXLIGHT Classic 602	PVC FLEXLIGHT Classic 602 FINESTRATO
147		
172		
197		
250		
300		
350		
400		
500		

Tenda laterale in PVC Flexlight classic 602 con cerniera di chiusura centrale, disponibili anche con finestre in PVC Cristal. Sistema di scorrimento con anelli in plastica.

NB: prezzo per singola campata

NB: aggiungere aste per tende

NB: per i colori disponibili vedi pag. 6

NB: le confezioni dei teli laterali possono avere saldature asimmetriche

OPZIONI COLORE | GAZEBO E PERGOLE



STRUTTURA

Verniciatura elettrostatica a polveri di poliestere.
Fasce di prezzo riportate nelle rispettive colonne a listino.
Per colori differenti richiedere fattibilità, costi e tempi di produzione.

	colonna 1	anthracite 					
	colonna 2	tundra 	taupe 	mars 	brown 	black 	
	colonna 3	white 9010 	oyster white 1013 	satin 			

FLEXLIGHT CLASSIC 602

semi-gloss PVC membrane
waterproof
weight 650 g/m²
height 267 cm
fire rating
euro class EN 13501-1(B-s2-d0)
warranty 3 years
use RWP, CDE

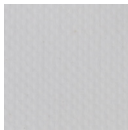
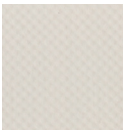
bianco 6285-102 	champagne 6285-341 
---	--







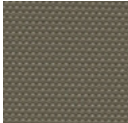

OPATEX PRO

PVC membrane with blackout film
internal textile effect
waterproof
weight 850 g/m²
height 300 cm
fire rating uni 9177: class 2
euro class EN 13501-1: B-s2-d0
warranty 5 years
use RWP

bianco 6693-112 	champagne 6693-272 
---	--

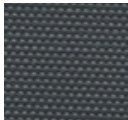
FLEXLIGHT LODGE 6002

PVC membrane with textile effect
waterproof
weight 630 g/m²
height 260-300 cm
fire rating uni 9177: class 2
euro class EN 13501-1(B-s2-d0)
warranty 5 years
use RWP, CDE

bianco 6002-20183 	taupe 6002-20165 	vaniglia 6002-10387 	grigio chiaro 6002-20001 	grigio 6002-20024 
antracite 6002-20205 	beige scuro 6002-20329 	argilla marrone 6002-20331 	verde 6002-20330 	

SOLTIS HORIZON 86

perforated PVC membrane
shading
weight 380 g/m²
height 177-267 cm
fire rating uni 9177: class 1
euro class EN 13501-1: B-s2-d0
warranty 5 years
use RSH,CTE,SSH

6572-2044

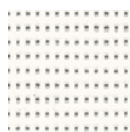

6572-2175



6572-2047

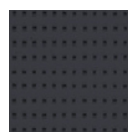

6572-2171

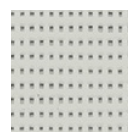

6572-2135

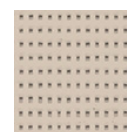

6572-2158

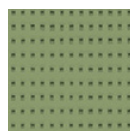

SOLTIS LOUNGE 96

micro-perforated PVC membrane
shading
weight 400 g/m²
height 120-267 cm
fire rating uni 9177: class 2
warranty 5 years
use CTE

6532-8102

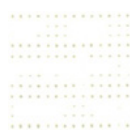

6532-1103



6532-2047



6532-2171

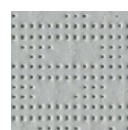

6532-2135



6532-50848



TENTMESH

HDPE polyethylene net
shading
weight 340 g/m²
height 300 cm
warranty 10 years
use SSH

8020-759



8020-704

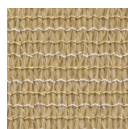

PVC CRISTAL 500 1S

transparent PVC membrane
waterproof
weight 610 g/m²
height 140 cm
use CDE, CTE

8707

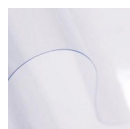

IRISUN SHADE SOLIDS

solution-dyed ACRYLIC fabric
stiff handle
water repellent, anti-mould, anti-stain
weight 290 g/m²
height 120 cm
warranty 10 years
use RWR, SWR, CTE

3400-G042



RAYTENT SHADE

solution-dyed ACRYLIC fabric
>50% recycled fibre
stiff handle
water repellent, anti-mould, anti-stain
weight 290 g/m²
height 120 cm
warranty 10 years
use RWR, SWR, CTE

3705-201



3705-801



3705-890



3705-704



PROGAR 2913

yarn-dyed ACRYLIC fabric
semi-soft handle
water repellent, anti-mould
weight 290 g/m²
height 247 cm
use CDE, CC

3674-010



3674-000



PROGAR 2021

solution dyed weft and yarn-dyed warp
semi-soft handle
water repellent, anti-mould
weight 290 g/m²
height 247 cm
use CDE, CC

3676-688

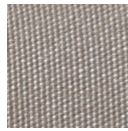

IRISUN LIVING PLAIN

solution-dyed ACRYLIC fabric
soft handle
water repellent, anti-mould, anti-stain
weight 240 g/m²
height 137 cm
warranty 5 years
use CDE, CC

3399-071

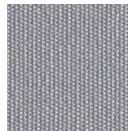

3399-014



ACRYLSHED

solution-dyed ACRYLIC fabric
light handle
water repellent, anti-mould, anti-stain
weight 130 g/m²
height 250 cm
warranty 5 years
use CDE, CC

3364-016

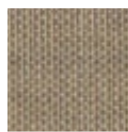

3364-016

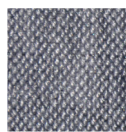

3364-010

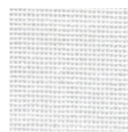

3364-386



RAYTENT DRAPERY

solution-dyed ACRYLIC fabric
>50% recycled fibre
light handle
water repellent, anti-mould, anti-stain
weight 140 g/m²
height 300 cm
warranty 5 years
use CDE, CC

3708-001



3708-801



3708-502



POLYSHED

POLYESTER fabric
light handle
water repellent, anti-mould, anti-stain
weight 120 g/m²
height 320 cm
use CDE, CC

3368-010

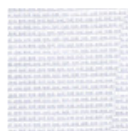

DRAP

solution-dyed ACRYLIC fabric
light handle
water repellent, anti-mould, anti-stain
weight 210 g/m²
height 280 cm
warranty 5 years
use CDE, CC

3737-974



PROMESH

solution-dyed ACRYLIC fabric mesh
soft handle
water repellent, anti-mould, anti-stain
weight 210 g/m²
height 260 cm
warranty 5 years
use CDE, CC

3621-010

