

OUTDOOR LIVING
& SHADING EXPERIENCE

CLASSICO





COMPANY PROFILE

Dal 1998 nella più vera tradizione della bottega italiana Unosider disegna e produce gazebo, pergolati e strutture di protezione solare e da condizioni meteo avverse.

Per i clienti più attenti ed esigenti Unosider offre soluzioni complete, anche chiavi in mano, per l'arredo degli spazi esterni.

Un costante lavoro di ampliamento della gamma e perfezionamento dei prodotti si rinnova di stagione in stagione con la passione e l'energia che ci contraddistinguono da sempre.

Da questa passione nascono tutti i progetti su misura, le personalizzazioni, gli accessori e la ricerca di armonizzazione dello spazio esterno che spesso va oltre la nostra produzione standard – già ampia – e che amiamo sintetizzare con l'etichetta "Architetture per Esterni".

La nostra mission è porre al centro dell'attenzione i desideri e le necessità del cliente e "cucire per lui un abito perfetto realizzato con i migliori materiali" e i nostri più grandi motivi di orgoglio sono l'apprezzamento dei clienti e l'ottima valutazione nazionale e internazionale raggiunta dai nostri prodotti.

Continuiamo il nostro percorso nello sviluppo del mondo outdoor con l'obiettivo di accompagnare i vostri momenti più felici e di relax all'ombra delle nostre strutture.

Unosider have followed the tradition of Italian design excellence in the manufacture of sun and weather protection systems such as gazebos & pergolas since 1998.

Complete solutions to furnish outdoor spaces are created for the most discerning customers and the product range is constantly improved through the enthusiastic adaption of new technologies and materials.

From the knowledge of what is possible comes the ability to create tailored solutions for individual projects.

Unosider passionately believe in the concept of "Outdoor Architecture," the harmonisation of the wishes and needs of customers with the best and most attractive way to achieve them for the exterior environment.

Our greatest pride comes from the appreciation of our customers around the world.

We will continue on our mission to create the very best shade structures.

architetture per esterni
UNOSIDER





OTTOEMEZZO MAXI

GAZEBO

Gazebo dalle linee pulite e dimensionato per soddisfare l'esigenza di coprire superfici fino a 6x6 metri.

Adatto sia all'uso residenziale che per attività ricettive.

La raccolta dell'acqua piovana all'interno del trave perimetrale e lo scarico a terra attraverso le piantane permettono l'unione modulare di più strutture per realizzare ambienti di dimensioni importanti in completa armonia con l'ambiente circostante.

This Gazebo has clean lines and is sized to cover areas up to 6x6m. It is suitable for accommodation in both residential and business use. Rainwater is collected within the perimeter beam and drains through the pillars. This allows the modular combination of several structures to create areas of significant size in complete harmony with their surroundings



Misure standard: da 4x4 a 6x6 metri
Realizzabile su misura
Scheda tecnica pag 126

*Standard size: from m 4x4 to m 6x6
Custom size available
Technical sheets page 126*

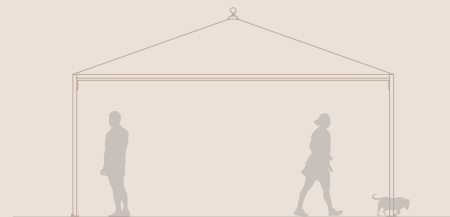





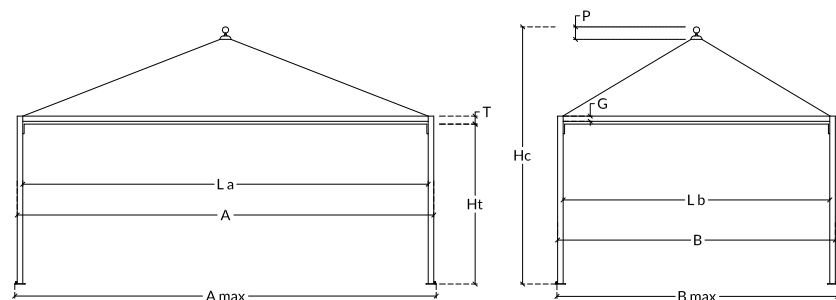
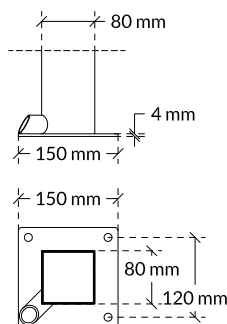
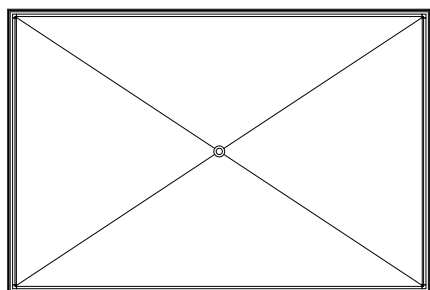

MISURE STANDARD STANDARD MEASURES

cm	400x400	400x500	500x500	400x600	500x600	600x600
A	400	400	500	400	500	600
B	400	500	500	600	600	600
La	384	384	484	484	484	584
Lb	384	484	484	584	584	584
Amax	407	407	507	407	507	607
Bmax	407	507	507	607	607	607
T	11,5	11,5	11,5	11,5	11,5	11,5
G	7,5	7,5	7,5	7,5	7,5	7,5
Ht	230	230	230	230	230	230
P	25	25	25	25	25	25
Hc	342	352	362	362	372	382

INFORMAZIONI TECNICHE TECHNICAL INFORMATION

- sezione pilastro 80x80x2 mm
 - sezione trave 115x75 mm sp 2mm
 - sezione spioventi 40x40x2 mm
 - dimensione massima 600x600 cm
 - possibilità di realizzazione su misura
 - profili in acciaio lavorato con trattamento di zincatura a caldo
 - verniciatura a polveri epossidiche a base di resina poliestere, resistente ai raggi UV
 - possibilità di personalizzazione della verniciatura (con riferimento alla cartella colori RAL) previa approvazione dell'ufficio tecnico
 - deflusso e canalizzazione delle acque meteoriche, garantito dalla presenza di grondaie perimetrali e di una canalizzazione interna ai pilastri
 - telo di copertura standard in PVC PRECONTRAINT 602, termosaldato, ignifugo classe 2/UNI9177, in colore champagne o bianco
- pillar section 80x80x2 mm
 - beam section 115x75 mm thickness 2 mm
 - sloping beam section 40x40x2 mm
 - maximum size 600x600 cm
 - customized available
 - steel profiles worked with hot dip galvanizing treatment
 - epoxy powder coating resin polyester, UV-resistant
 - customized powder coating available in other RAL color on request (prior approval of the technical office)
 - runoff and channeling rainwater, guaranteed by the presence of the gutter and the duct system set inside the pillars
 - standard awning in PVC PRECONTRAINT 602, sealed, flame retardant class 2/UNI9177, in champagne or white color

OPZIONI COLORE COLOUR OPTION

Struttura Structure:

Colore standard *standard colour*

antracite *anthracite*

Disponibile su quotazione
Available on quotations

tortora *taupe*

ruggine *rust*

sabbia *sand*

bianco 9010 *9010 white*

bianco 1013 *1013 white*

bianco opaco *matt white*

Telo di copertura Awning colours:

Tessuto standard *standard fabric*

PVC Preconstraint 602

champagne *champagne*

bianco *white*

Altre tipologie e colorazioni di tessuto
visionabili a pag 144

Other types and color of fabric at page 144

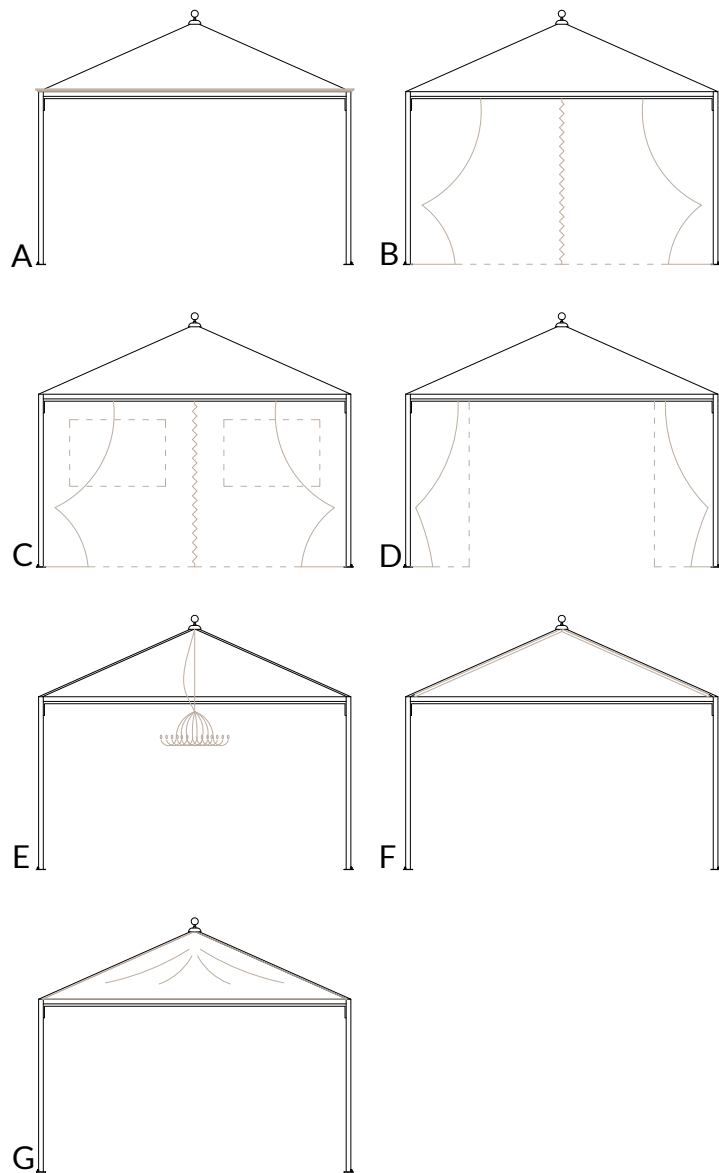

ACCESSORI OPTIONALS

- | | | | |
|---|--|---|---|
| A | cornice decorativa | A | decorative frame |
| B | tende laterali in tessuto acrilico Progar o in PVC con cerniera di chiusura e profili di fissaggio alle colonne | B | side curtains in Progar fabric with zipper closure and fastening profiles to the columns |
| C | tende laterali in PVC con cerniera di chiusura e sistema di fissaggio alle colonne, con finestrature personalizzate in PVC Cristal | C | side curtains in PVC fabric with zipper closure and fastening system to the column, with personalized windows in PVC Cristal fabric |
| D | tende ornamentali in acrilico Progar per decorazione della struttura | D | decorative curtains in Progar acrylic fabric for decoration facilities |
| E | lampadario a sospensione, in ferro lavorato (nei colori della struttura) o in cristallo | E | suspended chandelier, wrought iron (in the colors of the frame) or crystal |
| F | strisce LED dimmerabili integrate negli spioventi, dotate di telecomando | F | dimnable LED strips integrated into the inclined beams, equipped with remote control |
| G | controsoffitto teso o plissettato in tessuto acrilico Drap | G | stretched or pleated ceiling in Drap acrylic fabric |

GAZEBO E PERGOLE Opzioni colore *Colour option*



Struttura *Structure*
verniciatura elettrostatica a polvere di poliestere

antracite
anthracite



ruggine
russet



tortora
taupe



sabbia
sand



bianco 1013
white 1013



bianco 9010
white

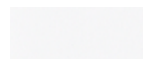

bianco opaco
matt white

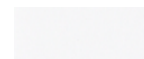

Telo di copertura *Awning colors*

PVC PRECONTRAINT 602

impermeabile *waterproof fabric*
peso *weight* 590 g/m²
altezza *widht* 180 cm

reazione al fuoco *fire rating* M2/NFP92-507
B1/DIN 4102-1
CLASSE 2/UNI9177

resistenza alla temperatura *resistance to temperatures* +70°/-30°
riciclabile *recyclable*
garanzia anni *warranty years* 5

bianco
white

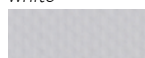

GTOT 0,09

champagne
champagne

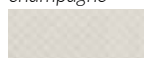

GTOT 0,08

PVC PRECONTRAINT 502

impermeabile *waterproof fabric*
peso *weight* 750 g/m²
altezza *widht* 267 cm

reazione al fuoco *fire rating* M2/NFP92-507
B1/DIN 4102-1
CLASSE 2/UNI9177

resistenza alla temperatura *resistance to temperatures* +70°/-30°
riciclabile *recyclable*
garanzia anni *warranty years* 5

beige sabbaiato
sand beige

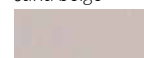

GTOT 0,09

pepe
pepe



GTOT 0,07

ciottolo
pebble



GTOT 0,07

PVC STAM

impermeabile *waterproof fabric*
peso *weight* 630 g/m²
altezza *widht* 260 cm

reazione al fuoco *fire rating* M2/NFP92-507
B1/DIN 4102-1
CLASSE 2/UNI9177

resistenza alla temperatura *resistance to temperatures* +70°/-30°
riciclabile *recyclable*
garanzia anni *warranty years* 5

bianco
white



GTOT 0,08

tortora
taupe



GTOT 0,09

antracite
anthracite



GTOT 0,08

ciottolo
pebble



GTOT 0,06

vaniglia
vanilla



GTOT 0,07

PVC OPATEX

impermeabile *waterproof fabric*
peso *weight* 850 g/m²
altezza *widht* 300 cm

reazione al fuoco *fire rating* M2/NFP92-507
B1/DIN 4102-1
CLASSE 2/UNI9177

resistenza alla temperatura *resistance to temperatures* +70°/-30°
riciclabile *recyclable*
garanzia anni *warranty years* 5
oscurante *block out*

bianco
white



GTOT 0,02

champagne
champagne



GTOT 0,03

ACRILICO

idrorepellente antimuffa *water repellent anti-mould*
peso *weight* 290 g/m²
altezza *widht* 120 cm
riciclabile *recyclable*
garanzia anni *warranty years* 10

bianco
white



tortora
taupe





Tessuti tende *Fabrics for curtains*

ACRILICO PROGAR

idrorepellente antimuffa *water repellent anti-mould*
 peso *weight* 290 g/m²
 altezza *widht* 182cm

bianco
white



tortora
taupe



écru
écru



PVC PRECONTRAIN 602

impermeabile *waterproof fabric*
 peso *weight* 590 g/m²
 altezza *widht* 180 cm
 reazione al fuoco *fire rating* M2/NFP92-507
 B1/DIN 4102-1
 CLASSE 2/UNI9177
 resistenza alla temperatura *resistance to temperatures* +70°-30°
 riciclabile *recyclable*
 garanzia anni *warranty years* 5

bianco
white

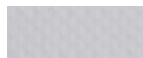

champagne
champagne

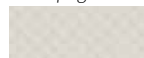

PVC PRECONTRAIN 502

impermeabile *waterproof fabric*
 peso *weight* 750 g/m²
 altezza *widht* 267 cm
 reazione al fuoco *fire rating* M2/NFP92-507
 B1/DIN 4102-1
 CLASSE 2/UNI9177
 resistenza alla temperatura *resistance to temperatures* +70°-30°
 riciclabile *recyclable*
 garanzia anni *warranty years* 5

beige sabbaiato
sand beige



pepe
pepe



GTOT 0,09

GTOT 0,07

ciottolo
pebble



GTOT 0,07

PVC CRISTAL

impermeabile *waterproof fabric*
 peso *weight* 610 g/m²
 altezza *widht* 132 cm
 reazione al fuoco *fire rating* M2/NFP92-507
 B1/DIN 4102-1
 CLASSE 2/UNI9177
 resistenza alla temperatura *resistance to temperatures* +60°-10°

trasparente
transparent



GTOT 0,55