

OUTDOOR LIVING
& SHADING EXPERIENCE

CLASSICO





COMPANY PROFILE

Dal 1998 nella più vera tradizione della bottega italiana Unosider disegna e produce gazebo, pergolati e strutture di protezione solare e da condizioni meteo avverse.

Per i clienti più attenti ed esigenti Unosider offre soluzioni complete, anche chiavi in mano, per l'arredo degli spazi esterni.

Un costante lavoro di ampliamento della gamma e perfezionamento dei prodotti si rinnova di stagione in stagione con la passione e l'energia che ci contraddistinguono da sempre.

Da questa passione nascono tutti i progetti su misura, le personalizzazioni, gli accessori e la ricerca di armonizzazione dello spazio esterno che spesso va oltre la nostra produzione standard - già ampia - e che amiamo sintetizzare con l'etichetta "Architetture per Esterni".

La nostra mission è porre al centro dell'attenzione i desideri e le necessità del cliente e "cucire per lui un abito perfetto realizzato con i migliori materiali" e i nostri più grandi motivi di orgoglio sono l'apprezzamento dei clienti e l'ottima valutazione nazionale e internazionale raggiunta dai nostri prodotti.

Continuiamo il nostro percorso nello sviluppo del mondo outdoor con l'obiettivo di accompagnare i vostri momenti più felici e di relax all'ombra delle nostre strutture.

Unosider have followed the tradition of Italian design excellence in the manufacture of sun and weather protection systems such as gazebos & pergolas since 1998.

Complete solutions to furnish outdoor spaces are created for the most discerning customers and the product range is constantly improved through the enthusiastic adaption of new technologies and materials.

From the knowledge of what is possible comes the ability to create tailored solutions for individual projects.

Unosider passionately believe in the concept of "Outdoor Architecture," the harmonisation of the wishes and needs of customers with the best and most attractive way to achieve them for the exterior environment.

Our greatest pride comes from the appreciation of our customers around the world.

We will continue on our mission to create the very best shade structures.

architetture per esterni
UNOSIDER





PRESTIGE

GAZEBO

Il gazebo Prestige nasce dal successo del Novecento di cui riprende la decorazione del trave. Il modello è arricchito con migliori tecniche costruttive. Una soluzione ottimale tra il più imponente Malatesta, consigliato per coperture sopra i 16m² e il Novecento. La struttura in ferro lavorato è sempre zincata a caldo e verniciata con polveri poliesteri in linea con lo standard di tutti i prodotti Unosider.

The pavilion Prestige comes from the success of pavilion Novecento with some technical improvements. It is an optimal solution between the massive Malatesta gazebo, ideal for covering over 16m² and the Novecento. The frame is made in galvanized wrought iron, and is polyester powder coated: all in line with the quality standards of all the Unosider gazebos and pergolas.



Misure standard: da 3×3 metri a 5×5 metri
Realizzabile su misura
Scheda tecnica pag 116

*Standard size: m 3×3 to m 5×5
Custom size available
Technical sheets page 116*

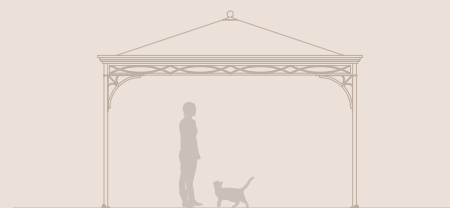



**MANTOVANA IN
LAMIERA
VALANCE SHEET**

Chiusura degli elementi decorativi del trave con mantovana in lamiera metallica interna. Opzionale.

-
Optional closure of the decorative elements of the beam with an internal painted iron valance is available.



**COPERTURA IN STAM
AWNING IN STAM
FABRIC**

Possibilità di realizzare la copertura in STAM, pvc con effetto tessitura. Opzionale.

-
Optional canopy roof in STAM fabric (pvc with elegant cloth effect).



**CONTROSOFFITTO TESO
FALSE CEILING**

Controsoffitto in acrilico realizzabile in versione tesa o plissettata. Opzionale.

-
A false ceiling in acrylic fabric is available in either a taut or draped version.





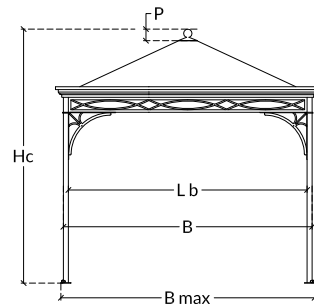
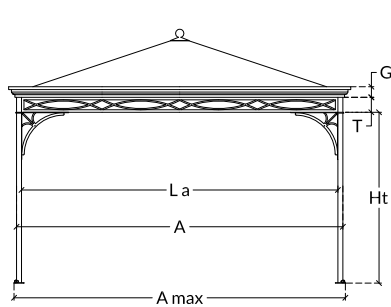
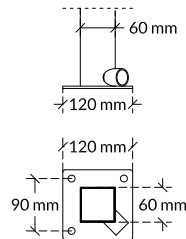
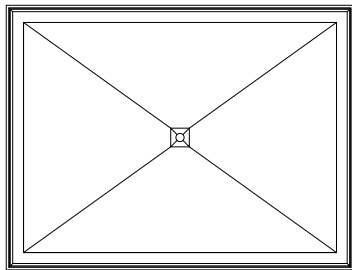

MISURE STANDARD STANDARD MEASURES

cm	300x300	300x400	400x400	400x500	500x500
A	300	300	400	400	500
B	300	400	400	500	500
La	288	288	388	388	488
Lb	288	388	388	488	488
Amax	306	306	406	406	506
Bmax	306	406	406	506	506
G	7,5	7,5	7,5	7,5	7,5
T	18	18	18	18	26
Ht	206	206	206	206	206
P	20	20	20	20	20
Hc	300	305	310	320	330

INFORMAZIONI TECNICHE TECHNICAL INFORMATION

- sezione pilastro 60x60x2 mm
 - sezione trave 180x25 mm sp 1,5 mm
 - sezione spioventi 30x30x2 mm
 - dimensione massima 500x500 cm
 - possibilità di realizzazione su misura
 - profili in acciaio lavorato con trattamento di zincatura a caldo
 - verniciatura a polveri epossidiche a base di resina poliestere, resistente ai raggi UV
 - possibilità di personalizzazione della verniciatura (con riferimento alla cartella colori RAL) previa approvazione dell'ufficio tecnico
 - deflusso e canalizzazione delle acque meteoriche garantito dalla presenza di grondaie perimetrali e di una canalizzazione interna ai pilastri
 - telo di copertura standard in PVC PRECON-TRAIINT 602, termosaldato, ignifugo classe 2/UNI9177, in colore champagne o bianco
- pillar section 60x60x2 mm
 - beam section 180x25 mm thickness 1,5 mm
 - sloping beam section 30x30x2 mm
 - maximum size 500x500 cm
 - customized available
 - steel profiles worked with hot dip galvanizing treatment
 - epoxy powder coating resin polyester, UV-resistant
 - customized powder coating available in other RAL color on request (prior approval of the technical office)
 - runoff and channeling rainwater, guaranteed by the presence of the gutter and the duct system set inside the pillars
 - standard awning in PVC Ferrari, sealed, flame retardant class 2/UNI9177, in champagne or white color

OPZIONI COLORE COLOUR OPTION

Struttura Structure:

Colore standard *standard colour*

antracite *anthracite*

Disponibile su quotazione
Available on quotations

tortora *taupe*

ruggine *rust*

sabbia *sand*

bianco 9010 *9010 white*

bianco 1013 *1013 white*

bianco opaco *matt white*

Telo di copertura *Awning colours:*

Tessuto standard *standard fabric*

PVC Preconstraint **602**

champagne *champagne*

bianco *white*

Altre tipologie e colorazioni di tessuto
visionabili a pag 144

Other types and color of fabric at page 144

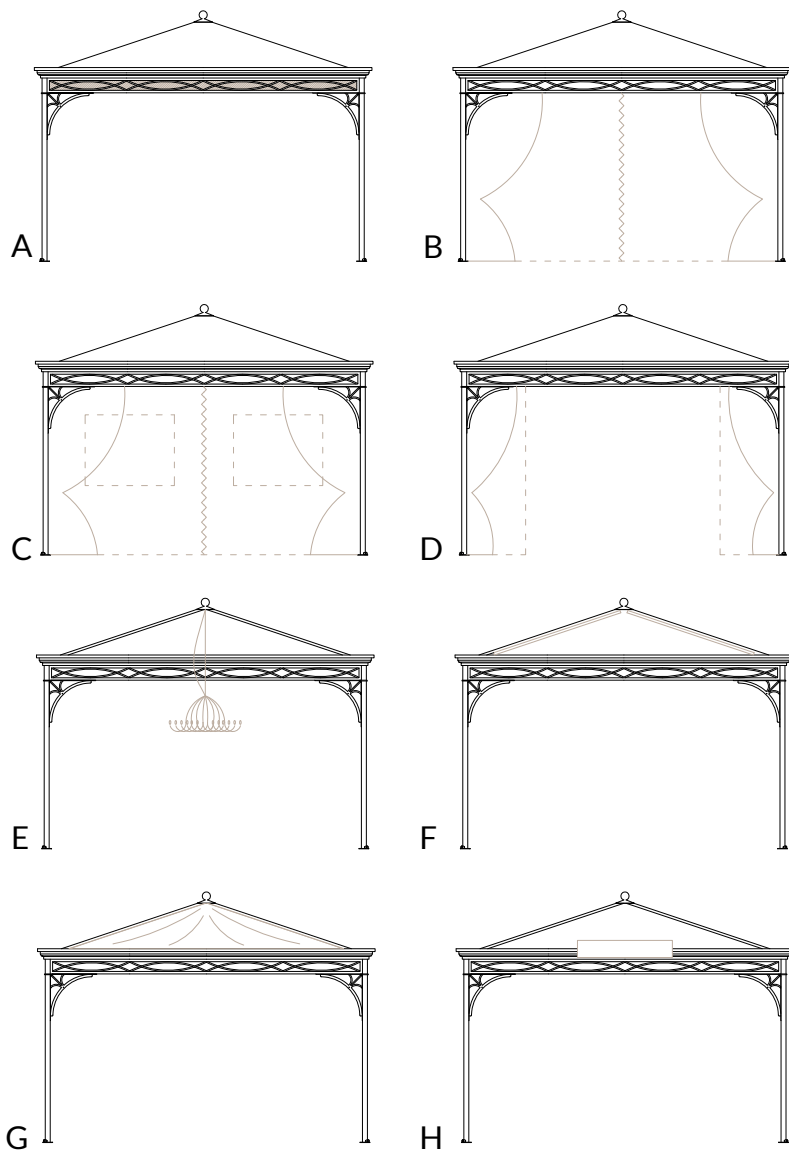

ACCESSORI OPTIONALS

- A**
mantovana in tessuto PVC o in lamiera di ferro verniciata
- B**
tende laterali in tessuto acrilico Progar o in PVC con cerniera di chiusura e fissaggio alle colonne con fasce in tessuto
- C**
tende laterali in PVC con cerniera di chiusura e profili di fissaggio alle colonne, con finestrate personalizzate in PVC Cristal
- D**
tende ornamentali in acrilico Progar per decorazione della struttura
- E**
lampadario a sospensione, in ferro lavorato (nei colori della struttura) o in cristallo.
- F**
strisce LED dimmerabili integrate negli spioventi o nelle travi perimetrali, dotate di telecomando
- G**
controsoffitto teso o plissettato in tessuto acrilico Drap
- H**
riscaldatori a luce ambiente con schermo in ceramica per il riscaldamento degli spazi outdoor
- A**
valance in PVC fabric or in painted iron sheet
- B**
side curtains in Progar fabric or in PVC fabric with zipper closure and fastening to the columns with fabric strips
- C**
side curtains in PVC fabric with zipper closure and fastening system to the column, with personalized windows in PVC Cristal fabric
- D**
decorative curtains in Progar acrylic fabric for decoration facilities
- E**
suspended chandelier, wrought iron (in the colors of the frame) or crystal.
- F**
dimnable LED strips integrated into the inclined beams or in the perimeter beams, equipped with remote control
- G**
stretched or pleated ceiling in Drap acrylic fabric
- H**
infrared heaters in ambient light with ceramic screen for heating outdoor spaces

GAZEBO E PERGOLE Opzioni colore *Colour option*



Struttura *Structure*
verniciatura elettrostatica a polvere di poliestere

antracite
anthracite



ruggine
russet



tortora
taupe



sabbia
sand



bianco 1013
white 1013



bianco 9010
white

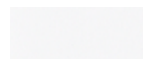

bianco opaco
matt white

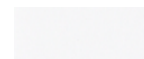

Telo di copertura *Awning colors*

PVC PRECONTRAIPT 602

impermeabile *waterproof fabric*
peso *weight* 590 g/m²
altezza *widht* 180 cm

reazione al fuoco *fire rating* M2/NFP92-507
B1/DIN 4102-1
CLASSE 2/UNI9177

resistenza alla temperatura *resistance to temperatures* +70°/-30°
riciclabile *recyclable*
garanzia anni *warranty years* 5

bianco
white

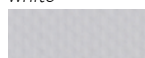

GTOT 0,09

champagne
champagne

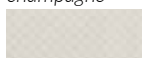

GTOT 0,08

PVC PRECONTRAIPT 502

impermeabile *waterproof fabric*
peso *weight* 750 g/m²
altezza *widht* 267 cm

reazione al fuoco *fire rating* M2/NFP92-507
B1/DIN 4102-1
CLASSE 2/UNI9177

resistenza alla temperatura *resistance to temperatures* +70°/-30°
riciclabile *recyclable*
garanzia anni *warranty years* 5

beige sabbaiato
sand beige

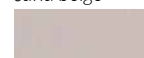

GTOT 0,09

pepe
pepe



GTOT 0,07

ciottolo
pebble



GTOT 0,07

PVC STAM

impermeabile *waterproof fabric*
peso *weight* 630 g/m²
altezza *widht* 260 cm

reazione al fuoco *fire rating* M2/NFP92-507
B1/DIN 4102-1
CLASSE 2/UNI9177

resistenza alla temperatura *resistance to temperatures* +70°/-30°
riciclabile *recyclable*
garanzia anni *warranty years* 5

bianco
white



GTOT 0,08

tortora
taupe



GTOT 0,09

antracite
anthracite



GTOT 0,08

ciottolo
pebble



GTOT 0,06

vaniglia
vanilla



GTOT 0,07

PVC OPATEX

impermeabile *waterproof fabric*
peso *weight* 850 g/m²
altezza *widht* 300 cm

reazione al fuoco *fire rating* M2/NFP92-507
B1/DIN 4102-1
CLASSE 2/UNI9177

resistenza alla temperatura *resistance to temperatures* +70°/-30°
riciclabile *recyclable*
garanzia anni *warranty years* 5
oscurante *block out*

bianco
white



GTOT 0,02

champagne
champagne



GTOT 0,03

ACRILICO

idrorepellente antimuffa *water repellent anti-mould*
peso *weight* 290 g/m²
altezza *widht* 120 cm
riciclabile *recyclable*
garanzia anni *warranty years* 10

bianco
white



tortora
taupe





Tessuti tende *Fabrics for curtains*

ACRILICO PROGAR

idrorepellente antimuffa *water repellent anti-mould*
 peso *weight* 290 g/m²
 altezza *widht* 182cm

bianco
white



tortora
taupe



écru
écru



PVC PRECONTRAIINT 602

impermeabile *waterproof fabric*
 peso *weight* 590 g/m²
 altezza *widht* 180 cm
 reazione al fuoco *fire rating* M2/NFP92-507
 B1/DIN 4102-1
 CLASSE 2/UNI9177
 resistenza alla temperatura *resistance to temperatures* +70°-30°
 riciclabile *recyclable*
 garanzia anni *warranty years* 5

bianco
white

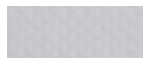

champagne
champagne

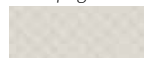

PVC PRECONTRAIINT 502

impermeabile *waterproof fabric*
 peso *weight* 750 g/m²
 altezza *widht* 267 cm
 reazione al fuoco *fire rating* M2/NFP92-507
 B1/DIN 4102-1
 CLASSE 2/UNI9177
 resistenza alla temperatura *resistance to temperatures* +70°-30°
 riciclabile *recyclable*
 garanzia anni *warranty years* 5

beige sabbaiato
sand beige

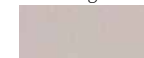

pepe
pepe



GTOT 0,09

GTOT 0,07

ciottolo
pebble



GTOT 0,07

PVC CRISTAL

impermeabile *waterproof fabric*
 peso *weight* 610 g/m²
 altezza *widht* 132 cm
 reazione al fuoco *fire rating* M2/NFP92-507
 B1/DIN 4102-1
 CLASSE 2/UNI9177
 resistenza alla temperatura *resistance to temperatures* +60°-10°

trasparente
transparent



GTOT 0,55