

metal

Armadi e sopralzi in metallo_Metal cupboards and superposition elements _Metal-Schränke und Aufsatzschränke
Armoires et superpositions en metal _Muebles y sobre mostrador metellicos

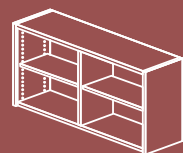

L. 100 P. 47 H. 85 cm
L. 120 P. 47 H. 85 cm



L. 150 P. 47 H. 85 cm
L. 180 P. 47 H. 85 cm

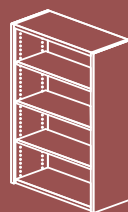

L. 100 P. 47 H. 155 cm
L. 120 P. 47 H. 155 cm



L. 150 P. 47 H. 155 cm
L. 180 P. 47 H. 155 cm



L. 100 P. 47 H. 200 cm
L. 120 P. 47 H. 200 cm

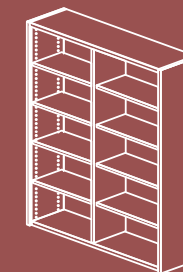

L. 150 P. 47 H. 200 cm
L. 180 P. 47 H. 200 cm





DATI TECNICI

Technical data/Technische Daten/Données techniques/Datos técnicos

H. 85 L. 100 P. 46

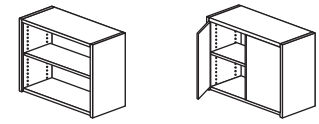

L. 120 P. 46

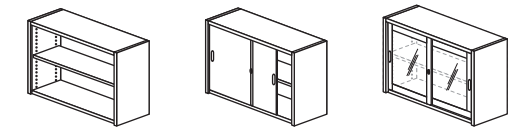

H. 85 L. 150 P. 46

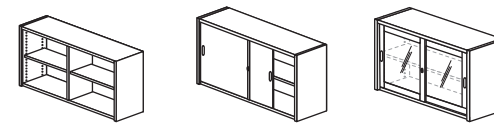

L. 180 P. 46

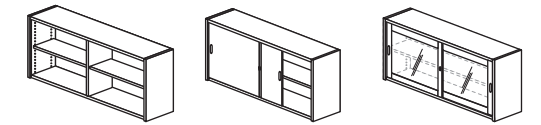

H. 155 L. 100 P. 46

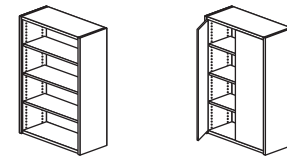

L. 120 P. 46



H. 155 L. 150 P. 46



L. 180 P. 46

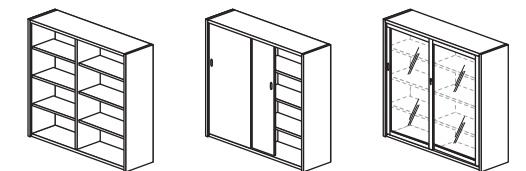

H. 200 L. 100 P. 46

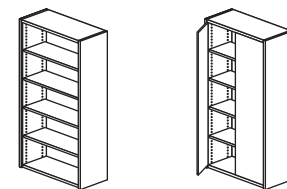

L. 120 P. 46

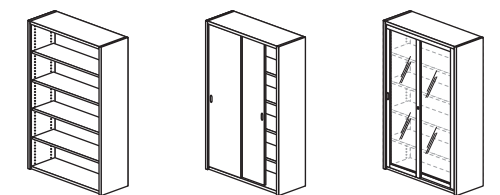

H. 200 L. 150 P. 46

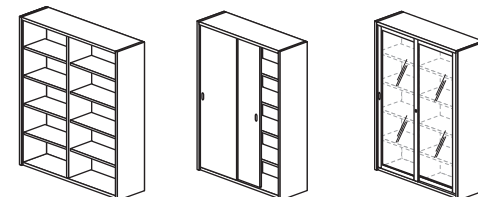

L. 180 P. 46



metal

metal

metal

Note importanti

- Le versioni a giorno e ad anta: battente, scorrevole e a vetro, vengono fornite di serie con ripiani interni.
- Le versioni a serrandina vengono fornite di serie senza ripiani interni.
- Opzionale supplemento coperchio con portacartelle per armadi da cm 100 - 120 (*) e da cm 150 - 180 (*).
- Opzionale supplemento coperchio con portacartelle per armadi a serrandina da cm 100 (*) e da cm 120 (*).
- I ripiani estraibili possono essere applicati fino ad un'altezza di 100 cm; oltre si dovrà procedere a fissare l'armadio alla parete.
- Opzionali i piedini regolabili nelle versioni a serrandina (pag. 22).
- Tutti gli accessori interni sono verniciati antracite (NA).
- Gli elementi vengono eseguiti solo nelle versioni evidenziate dai singoli prezzi.
- I pesi si intendono lordi con imballi in scatole.

Important notes

- All cupboards except ones with rolling doors have standard inside shelves.
- Standard out-fit of cabinets with roller doors is without shelves.
- Optional extra charge: top with filing rods for cupboards width 100 - 120 (*) width 150 - 180 (*).
- Optional extra charge: top with filing rods for cupboards with roller door width 100 (*) width 120 (*).
- Cupboards have to be fixed to the wall when pull-out shelves are applied over 100 cm height.
- Optionals: adjustable feet for cupboards with rolling doors (page 22).
- Inside accessories are all anthracite (NA) lacquered.
- Elements are available only with finishing stated by prices.
- Weights are gross weights packed in boxes.

Wichtige Hinweise

- Alle Regale, Flügel
- und Schiebetürenschränke sind mit Fachböden versehen.
- Die Module mit Jalousien werden serienmässig ohne Fachböden geliefert.
- Wahlweise: Deckel mit Vorrichtung für Pendelmappen für 100 - 120 cm b. Schränke (*) für 150 - 180 cm b. Schränke (*).
- Wahlweise: Deckel mit Vorrichtung für Pendelmappen für 100 cm b. Jalousieschränke (*) für 120 cm b. Jalousieschränke (*).
- Auszugsrahmen können bis auf 100 cm Höhe eingebaut werden. Über 100 cm muss der Schrank an die Wand befestigt werden.
- Wahlweise: Bodenausgleichsfüsschen für Jalousieschränke (Seite 22).
- Sämtliches Zubehör für Innenausrüstung ist Anthrazitgrau (NA) lackiert.
- Artikel sind nur in den angegebenen Verarbeitungen und zu den genannten Preisenerhältlich.
- Das Gewicht entspricht dem Brutto-Gewicht inklusive Verpackung.

Notes importantes

- Les meubles avec portes battentes, coulissantes ou vitrées sont fournis, de série, avec des étagères.
- La version avec rideaux est livrée, de série, sans étagères.
- En option, les tops des armoires peuvent être prédisposés pour dossiers suspendus.
- Supplément pour armoires larg. 100 - 120 cm (*) et larg. 150 - 180 cm (*).
- Supplément pour armoires avec rideaux larg. 100 cm (*) et larg. 120 cm (*).
- Les étagères extractables peuvent être montées jusqu'à 100 cm de hauteur. Au dessus l'armoire doit être fixée au mur.
- Les verins de réglage sont en option dans les versions avec rideaux (pag. 22).
- Tous les accessoires internes sont vernis anthracite (NA).
- Les éléments sont disponibles uniquement dans les versions indiquées pour chaque article.
- Les poids sont bruts avec emballage compris.

Importante

- Las veriones sin puertas y con puertas: batientes, correderas y con cristal incluyen de serie los estantes.
- Los muebles con persiana, de serie no tienen estantes internos.
- Opcional sobreprecio sobre con portacarpetas para armario de 100 - 120 cm. (*) y para el. de 150 - 180 (*)
- Opcional sobreprecio sobre con portacarpetas para armario con persiana de 100 cm. (*) y para el. de 120 cm. (*)
- Los estantes extraibles se pueden aplicar en las librerías hasta 100 cm de altura, si estas superan el metro se deben fijar al muro.
- Son opcionales en los armarios de persiana, los niveladores regulables (pag.22).
- Todos los accesorios internos son de color antracita.
- Los artículos se fabrican solo en las versiones indicadas en la presente tarifa.
- Los precios se entienden brutos con embalaje.

(*) OPTIONAL	L.	ART.	€uro
Supplemento coperchio con portacartelle per armadi Extra charge top with filing rods with lid for cupboard Mehrpreis für deckel mit Vorrichtung für Pendelmappen für Schränke Supplément pour tops prédisposé pour dossiers suspendus Sobreprecios para portacarpetas para armario	100 120 150 180	MCAPC10 MCAPC12 MCAPC15 MCAPC18	19 21 27 38
Supplemento coperchio con portacartelle per armadi a serrandina Extra charge top with filing rods with lid for cupboards with roller door Mehrpreis für deckel mit Vorrichtung für Pendelmappen für Jalousie schränke Supplément pour prédis position top pour dossiers suspendus armoires rideaux Sobreprecios para portacarpetas para armario con persiana	100 120	MCARC10 MCARC12	18 21

metal

MW - Struttura metallica

Metal structure - Metallgestell - Structure metallique - Estructura metallica

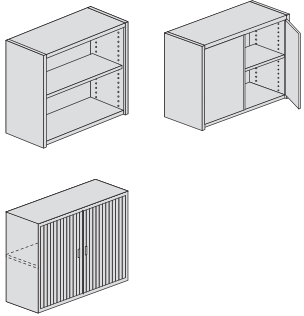

M - Top in melaminico

Melamine top - Melamin Abdeckplatte - Top en mélamine - Sobre en melaminico

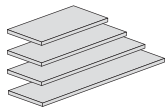

Accessori

Accessories - Zubehör - Accessoires - Accesorios

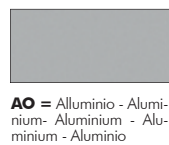
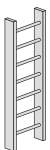
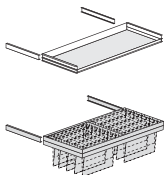
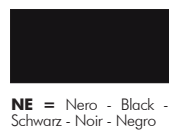
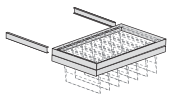
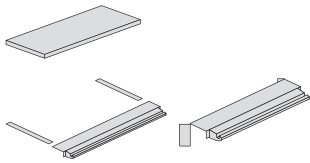

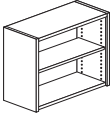
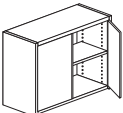
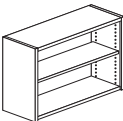
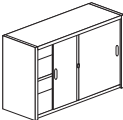
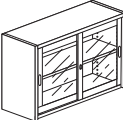
	L.	P.	H.	COD.	€ MW				Kg	mc
	100	47	85	MC1301	226				29,30	0,122
	100	47	85	MC1302	316				113,30	0,162
	120	47	85	MC1401	258				34,20	0,155
	120	47	85	MC1407	337				43,00	0,181
	120	47	85	MC1417	469				45,30	0,184

Armadi e sopralzi

Cupboards and upper elements
 Schränke und Aufsatzschränke
 Armoires et superpositions
 Muebles y sobre mostrador

(1) Struttura metallica

Metal structure - Metallgestell
 Structure metallique - Estructura metallica

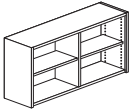
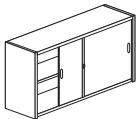
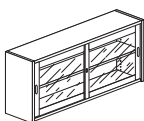

	L.	P.	H.	COD.	MW				Kg	mc
	150	47	85	MC1501	319				44,20	0,138
	150	47	85	MC1507	424				55,00	0,170
	150	47	85	MC1517	546				57,20	0,174
	180	47	85	MC1601	334				48,90	0,189
	180	47	85	MC1607	438				61,60	0,225
	180	47	85	MC1617	580				64,10	0,232

Armadi e sopralzi

Cupboards and upper elements
Schränke und Aufsatzschränke
Armoires et superpositions
Muebles y sobre mostrador

(1) Struttura metallica

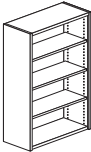
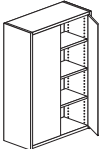
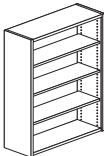
Metal structure - Metallgestell
Structure metallique - Estructura metallica

	L.	P.	H.	COD.	MW				Kg	mc
	100	47	155	MC3301	289				45,60	0,143
	100	47	155	MC3302	389				62,10	0,223
	120	47	155	MC3401	336				56,10	0,197
	120	47	155	MC3407	432				72,50	0,247
	120	47	155	MC3417	640				75,60	0,249

Armadi e sopralzi

Cupboards and upper elements
 Schränke und Aufsatzschränke
 Armoires et superpositions
 Muebles y sobre mostrador

(1) Struttura metallica

Metal structure - Metallgestell
 Structure metallique - Estructura metallica

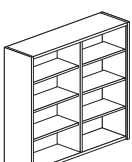
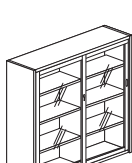
	L.	P.	H.	COD.	MW				Kg	mc
	150	47	155	MC3501	440				72,10	0,251
	150	47	155	MC3507	546				92,50	0,314
	150	47	155	MC3517	771				95,50	0,314
	180	47	155	MC3601	456				79,00	0,283
	180	47	155	MC3607	582				103,00	0,357
	180	47	155	MC3617	822				105,60	0,360

Armadi e sopralzi

Cupboards and upper elements
Schränke und Aufsatzschränke
Armoires et superpositions
Muebles y sobre mostrador

(1) **Struttura metallica**

Metal structure - Metallgestell
Structure metallique - Estructura metallica

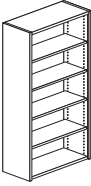
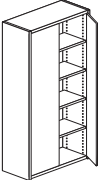
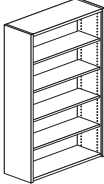
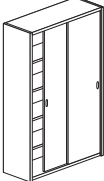
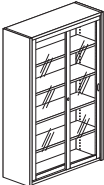
	L.	P.	H.	COD.	MW				Kg	mc
	100	47	200	MC4301	327				60,40	0,219
	100	47	200	MC4302	447				78,40	0,319
	120	47	200	MC4401	376				69,70	0,247
	120	47	200	MC4407	507				91,00	0,315
	120	47	200	MC4417	685				94,10	0,314

Armadi e sopralzi

Cupboards and upper elements

Schränke und Aufsatzschränke



Armoires et superpositions

Muebles y sobre mostrador

(1) **Struttura metallica**

Metal structure - Metallgestell

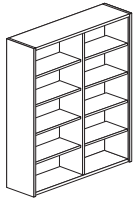
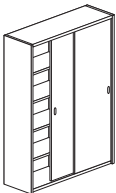
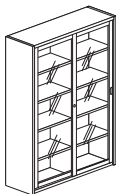
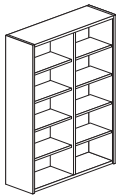
Structure metallique - Estructura metallica

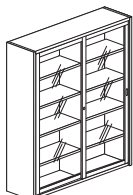
	L.	P.	H.	COD.	MW				Kg	mc
	150	47	200	MC4501	509				89,10	0,338
	150	47	200	MC4507	642				114,30	0,419
	150	47	200	MC4517	898				118,00	0,421
	180	47	200	MC4601	527				97,90	0,383
	180	47	200	MC4607	666				128,20	0,470
	180	47	200	MC4617	959				132,10	0,482

Armadi e sopralzi



Cupboards and upper elements
Schränke und Aufsatzschränke
Armoires et superpositions
Muebles y sobre mostrador

(1) **Struttura metallica**

Metal structure - Metallgestell
Structure metallique - Estructura metallica

metal

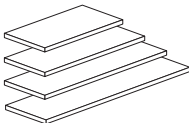
Accessori per armadi e sopralzi _Accessories for cupboards and upper elements _Zubehör für schränke und Aufsatzschränke
Accessoires pour armoires et superpositions _Accesorios para muebles y sobre mostrador

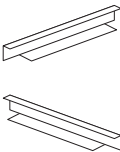
	L.	P.	H.	COD.	M	MW	ØØ	Kg	mc
	100	48	3	MCTP10	56			10,50	0,027
	120	48	3	MCTP12	65			13,00	0,031
	150	48	3	MCTP15	78			16,00	0,039
	180	48	3	MCTP18	88			19,00	0,047
<p>Top in nobilitato con bordo frontale ABS per mobili H. 85-155 Melamine top with ABS front edge for cupboards H. 85-155 cm Dekordeckel mit vorderer Kante in ABS für 85-155 cm. H. Schränke Top mélamine avec bord et frontal ABS pour meubles H. 85-155 Sobre en melamina con borde en ABS para muebles a. 85-155 cm.</p>									
	x 100 cm	100	47	MC800		22		3,40	0,000
	x 120 cm	120	47	MC802		26		4,40	0,013
	x 150 cm	70,5	38	MCAA20		20		2,70	0,008
	x 180 cm	85,5	38	MCAA21		21		3,20	0,010
<p>Ripiano interno in metallo Inside metal shelf Metall-Einlegeboden Étagère intérieur en métallique Estante interno metalico</p>									
				MCAA28			13	1,80	0,002
	<p>Coppia staffe di fissaggio sopralzo Pair of fixing brackets for upper element Paar Verbindungsbeschläge Élément pour superposition Juego elementos de fijación sobreelev</p>								

Finiture

Finishes - Oberflächen
Versions - Acabados

M Melaminico - Melamine - Melamin - Mélamine - Melaminico

MW Metallo - Metal - Metall - Métal - Metal

ØØ Neutro - Neutral - Farblos - Neutre - Neutro

metal

Accessori per armadi e sopralzi _Accessories for cupboards and upper elements_ _Zubehör für schränke und Aufsatzschränke_
 Accessoires pour armoires et superpositions _Accesorios para muebles y sobre mostrador

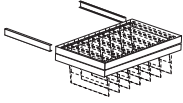
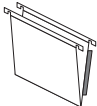
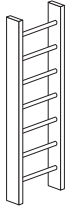
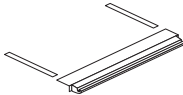
	L.	P.	H.	COD.				Kg	mc
	85,5	41		MCAA52 NE		117		5,00	0,000
Per cartelle sospese e tabulati For filing frame and listing Für Hängemappen und EDV-Mappen Cadres extractible Para carpetas colgantes y listados (per - for - für - pour - para 180 cm)									
	33			422 ØØ		82		4,00	0,026
Cartelle sospese cm 33 per armadio Suspended folders 33 cm for cupboard 33 cm breite Hängemappen für Schrank Dossiers susp. 33 cm pour meuble Carpetas colgantes 33 cm para mueble (50 pz. - pc. - St. - pièc. - piez)									
	38	210		MCAA23 AO		199		4,30	0,091
Scala tubolare in alluminio Aluminium ladder Aluminium-Leiter Echelle en aluminium Escalera tubular en aluminio						MW			
	100			MCAA35		41		5,00	0,017
	120			MCAA24		43		5,10	0,018
	150			MCAA25		45		6,00	0,022
	180			MCAA26		48		6,90	0,027
Reggiscala Ladder bracket Leiterführungsprofil Rail pour échelle Guia de escalera									

Finiture
 Finishes - Oberflächen
 Versions - Acabados

- NE** Nero - Black - Schwarz - Noir - Negro
- ØØ** Neutro - Neutral - Farblos - Neutre - Neutro
- AO** Alluminio - Aluminium - Aluminium - Aluminium - Aluminio
- MW** Metallo - Metal - Metall - Métal - Metal

metal

metal

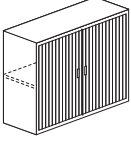
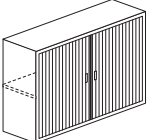
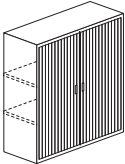
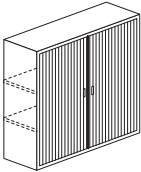
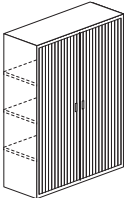
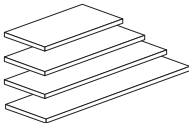
	L.	P.	H.	COD.	MW				Kg	mc
	100	47	85	MC1309	362				39,00	0,110
Senza ripiani Without shelves Ohne Böden Sans étagère Sin estante										
	120	47	85	MC1409	392				43,00	0,150
Senza ripiani Without shelves Ohne Böden Sans étagère Sin estante										
	100	47	105	MC8309	426				49,00	0,140
Senza ripiani Without shelves Ohne Böden Sans étagère Sin estante										
	120	47	105	MC8409	441				54,00	0,180
Senza ripiani Without shelves Ohne Böden Sans étagère Sin estante										
	100	47	155	MC3309	510				59,00	0,180
Senza ripiani Without shelves Ohne Böden Sans étagère Sin estante										
	100	48	3	MCTP10	56				10,50	0,027
	120	48	3	MCTP12	65				13,00	0,031
Top in nobilitato con bordo frontale ABS per mobili H. 85-155 Melamine top with ABS front edge for cupboards H. 85-155 cm Dekordeckel mit vorderer Kante in ABS für 85-155 cm. H. Schränke Top mélamine avec bord et frontal ABS pour meubles H. 85-155 Sobre en melamina con borde en ABS para muebles a. 85-155 cm.										

Armadi a serrandina

Cupboard with roller door
Jalousieschränke
Armoires avec rideaux
Muebles con persiana

(1) Struttura metallica

Metal structure - Metallgestell
Structure métallique - Estructura metallica

M = Melaminico - Melamine - Melamin - Mélamine - Melaminico

MW = Metallo - Metal - Metall - Métal - Metal

metal

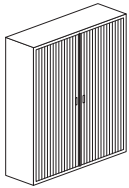
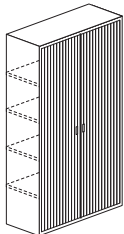
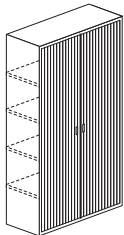
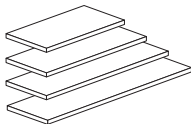
	L.	P.	H.	COD.	MW				Kg	mc					
				Senza ripiani Without shelves Ohne Böden Sans étagère Sin estante	120	47	155	MC3409	553				65,00	0,220	
				Senza ripiani Without shelves Ohne Böden Sans étagère Sin estante	100	47	200	MC4309	598				205,20	0,220	
				Senza ripiani Without shelves Ohne Böden Sans étagère Sin estante	120	47	200	MC4409	644				78,00	0,260	
					100	48	3	MCTP10	56				10,50	0,027	
					120	48	3	MCTP12	65				13,00	0,031	
Top in nobilitato con bordo frontale ABS per mobili H. 85-155 Melamine top with ABS front edge for cupboards H. 85-155 cm Dekordeckel mit vorderer Kante in ABS für 85-155 cm. H. Schränke Top mélamine avec bord et frontal ABS pour meubles H. 85-155 Sobre en melamina con borde en ABS para muebles a. 85-155 cm.															

Armadi a serrandina

Cupboard with roller door
Jalousieschränke
Armoires avec rideaux
Muebles con persiana

(1) Struttura metallica

Metal structure - Metallgestell

Structure métallique - Estructura metallica

M = Melaminico - Melamine - Melamin - Mélamine - Melaminico

MW = Metallo - Metal - Metall - Métal - Metal

metal

metal

Accessori per armadi e sopralzi _Accessories for cupboards and upper elements _Zubehör für schränke und Aufsatzschränke
 Accessoires pour armoires et superpositions _Accesorios para muebles y sobre mostrador

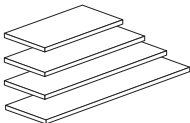
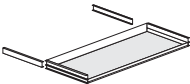
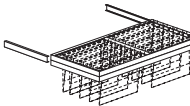
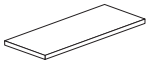
	L.	P.	H.	COD.	M	NA	MW	Kg	mc
	100	48	3	MCTP10	56			10,50	0,027
	120	48	3	MCTP12	65			13,00	0,031
Top in nobilitato con bordo frontale ABS per mobili H. 85-155 Melamine top with ABS front edge for cupboards H. 85-155 cm Dekordeckel mit vorderer Kante in ABS für 85-155 cm. H. Schränke Top mélamine avec bord et frontal ABS pour meubles H. 85-155 Sobre en melamina con borde en ABS para muebles a. 85-155 cm.									
	x 100 cm	85	41	MCAS50A		86		4,80	0,033
	x 120 cm	105	41	MCAS50B		98		5,00	0,035
Piano estraibile Extractable shelf Ausziehbrett Etagère extractable Estante extraíble									
	x 100 cm	85	41	MCAS52A		90		5,80	0,033
	x 120 cm	105	41	MCAS52B		105		5,90	0,034
Telaio estraibili porta cartelle e tabulati Listing frame Hängeauszug für EDV-Mappen Châssis télescopique pour listing Bastido para listados extraíble									
	x 100 cm	85	38	MCAS18			21	3,50	0,011
	x 120 cm	105	38	MCAS19			24	4,50	0,013
Piano interno in metallo Inside metal shelf Metall-Einlegeboden Etagère métallique Estante interno metálico									

Finiture
 Finishes - Oberflächen
 Versions - Acabados

M Melaminico - Melamine - Melamin - Mélamine - Melaminico
NA Antracite - Anthracite - Anthrazitgrau - Anthracite - Antracita
MW Metallo - Metal - Metall - Métal - Metal

metal

Accessori per armadi e sopralzi _Accessories for cupboards and upper elements_ _Zubehör für schränke und Aufsatzschränke_
 Accessoires pour armoires et superpositions _Accesorios para muebles y sobre mostrador_

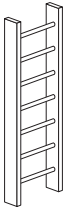
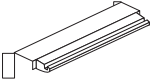
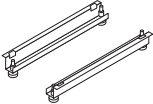
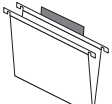
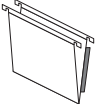
	L.	P.	H.	COD.	AO	MW	ØØ	Kg	mc
									
Scala tubolare in alluminio Aluminium ladder Aluminium-Leiter Echelle en aluminium Escalera tubular en aluminio	38		210	MCAA23 AO	199			4,30	0,091
	x 100 cm	100		MCAS37A		33		4,80	0,015
	x 120 cm	120		MCAS37B		34		5,10	0,018
									
Reggiscala Ladder bracket Leiterführungsprofil Rail pour échelle Guía de escalera									
				MCAA36			27	0,60	0,001
									
Set piedini con supporti Set of feet with supports Set Bodenausgleichsfüsschen m. Stützen Set verins avec supports Juego de pies con soportes									
	33			420 ØØ			68	4,00	0,020
									
Cartelle sospese per classificatore Suspended folders for filing Breite Hängemappen für HR-Lade Dossiers suspendus pour classeur Carpetas colgantes para archivos (50 pz. - pc. - St. - pièc. - piez)									
	39,5			421 ØØ			70	4,00	0,020
									
Cartelle sospese per classificatore Suspended folders for filing Breite Hängemappen für HR-Lade Dossiers suspendus pour classeur Carpetas colgantes para archivos (50 pz. - pc. - St. - pièc. - piez)									
	33			422 ØØ			82	4,00	0,026
									
Cartelle sospese cm 33 per armadio Suspended folders 33 cm for cupboard 33 cm breite Hängemappen für Schrank Dossiers susp. 33 cm pour meuble Carpetas colgantes 33 cm para mueble (50 pz. - pc. - St. - pièc. - piez)									

Finiture
Finishes - Oberflächen
Versions - Acabados





AO Alluminio - Aluminium - Aluminium - Aluminium - Alumini
MW Metallo - Metal - Metall - Métal - Metal
ØØ Neutro - Neutral - Farblos - Neutre - Neutro

metal

metal

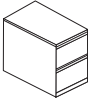
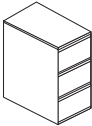
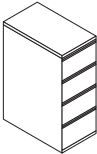
Classificatori

Filing cabinets _ Registraturschränke
 Classeur _ Archivos

	L.	P.	H.	COD.				Kg	mc
	51	69	76	MCSS2	400			80,00	0,270
	51	69	107	MCSS3	515			63,00	0,385
	51	69	138	MCSS4	637			48,00	0,496
	33			420 00	68			4,00	0,020
	39,5			421 00	70			4,00	0,020
	60		12	MCAC40 NA	15			0,20	0,000
Separatore longitudinale Lengthwise divider _ Längsverteiler Séparateur longitudinal _ Separador longitudinal									
	17		22,5	MCAC41 NA	8			0,05	0,000
Separatore oscillante Tilting divider _ Wendeplatte Séparateur oscillant _ Separador movil									
	38,5		22,5	MCAC42 NA	10			0,10	0,000
Separatore oscillante Tilting divider _ Wendeplatte Séparateur oscillant _ Separador movil									

Esempi di utilizzo

Examples on possible uses and combinations
 Zusammensetzungsbeispiele und kombinationsmöglichkeiten
 Exemples d'utilisations
 Ejemplos de utilización

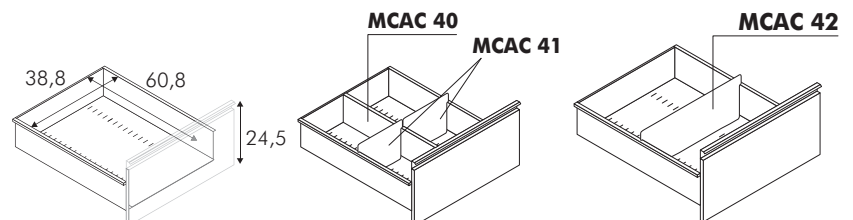

metal

Ricambi Spare Parts _Ersatzteile S.a.v. _Recambios		L.	P.	H.	COD.	ØØ		Kg	mc
Kit serratura per mobili con ante battenti Kit of lock for cupboard with wing doors Satz Schloss für Schrank mit Flügeltüren Kit serrures pour meuble avec portes battantes Juego de cerraduras para mueble con puertas					MCAA07	31		0,50	0,001
Kit serratura per mobili con ante scorrevoli Kit of lock for cupboard with sliding doors Satz Schloss für Schrank mit Glasschiebetüren Kit serrures pour meuble avec portes coulissantes Juego de cerraduras para mueble con puertas correderas					MCAA01	22		0,60	0,001
Kit serratura per mobili a serrandina Kit of lock for cupboard with roller doors Satz Schloss für Jalousieschränke Kit serrures pour meuble avec rideaux Juego de cerraduras para mueble con persiana					MCAA08	22		0,50	0,000
Coppia supporti per ripiani spostabili per mobili a giorno, con ante battenti o scorrevoli Pair of support for movable shelves for Bookshelves, cupboard with wing doors or sliding doors Paar Halterungen für Einlegeböden für Regalschränke, Flügeltüren, Flügeltürenschränke und Schiebetürenschränke Paire support pour étagère meubles à jour, portes battantes et coulissantes Pareja de soportes para estante móvil para muebles abierto, con puertas batientes o correderas					MCAA09	22		0,50	0,000
Coppia supporti per ripiani spostabili per mobili a serrandina Pair of support for movable shelves for cupboard with roller doors Paar Halterungen für Einlegeböden für Jalousieschränke Paire support pour étagère meubles avec rideaux Pareja de soportes para estantes móviles para armarios con persiana					MCAA10	22		0,50	0,000

Finiture
Finishes - Oberflächen
Versions - Acabados

ØØ Neutro - Neutral - Farblos - Neutre - Neutro

metal