

OUTDOOR LIVING
& SHADING EXPERIENCE

CLASSICO





COMPANY PROFILE

Dal 1998 nella più vera tradizione della bottega italiana Unosider disegna e produce gazebo, pergolati e strutture di protezione solare e da condizioni meteo avverse.

Per i clienti più attenti ed esigenti Unosider offre soluzioni complete, anche chiavi in mano, per l'arredo degli spazi esterni.

Un costante lavoro di ampliamento della gamma e perfezionamento dei prodotti si rinnova di stagione in stagione con la passione e l'energia che ci contraddistingue da sempre.

Da questa passione nascono tutti i progetti su misura, le personalizzazioni, gli accessori e la ricerca di armonizzazione dello spazio esterno che spesso va oltre la nostra produzione standard – già ampia – e che amiamo sintetizzare con l'etichetta "Architetture per Esterni".

La nostra mission è porre al centro dell'attenzione i desideri e le necessità del cliente e "cucire per lui un abito perfetto realizzato con i migliori materiali" e i nostri più grandi motivi di orgoglio sono l'apprezzamento dei clienti e l'ottima valutazione nazionale e internazionale raggiunta dai nostri prodotti.

Continuiamo il nostro percorso nello sviluppo del mondo outdoor con l'obiettivo di accompagnare i vostri momenti più felici e di relax all'ombra delle nostre strutture.

Unosider have followed the tradition of Italian design excellence in the manufacture of sun and weather protection systems such as gazebos & pergolas since 1998.

Complete solutions to furnish outdoor spaces are created for the most discerning customers and the product range is constantly improved through the enthusiastic adaption of new technologies and materials.

From the knowledge of what is possible comes the ability to create tailored solutions for individual projects.

Unosider passionately believe in the concept of "Outdoor Architecture," the harmonisation of the wishes and needs of customers with the best and most attractive way to achieve them for the exterior environment.

Our greatest pride comes from the appreciation of our customers around the world.

We will continue on our mission to create the very best shade structures.

UNOSIDER
architetture per esterni





NOVECENTO

PERGOLA ADDOSSATA WALL-MOUNTED PERGOLA

Morbidezza delle linee ed eleganza delle proporzioni per un ideale e naturale prolungamento della casa. Una protagonista indiscussa della nostra collezione da progettare nelle sue misure standard o adattare alla vostra abitazione per un risultato estetico perfetto. Possibilità di chiudere tutti i lati tramite teli in tessuto o PVC liscio o finestrato per uno spazio riparato in tutte le stagioni.

*A pergola with soft and elegant lines for the perfect house extension.
A beautiful, functional structure which is undisputed star of our collection and is built to fit its home.
All sides can be closed if you choose creating a structure for all seasons with curtains in plain PVC or curtains with windows.*



Misure standard: da 3×2,5 metri a 4×5 metri
+ estensioni
Realizzabile su misura
Scheda tecnica pag 134

*Standard size: from 3×2.5 to 4×5 meters +
extensions
Custom size available
Technical sheets page 134*

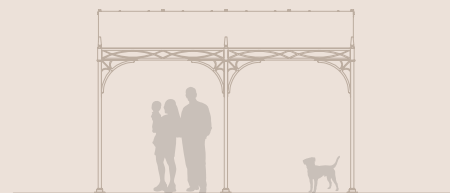



TRAVE LATERALE SIDE BEAM

Possibilità di inserire trave decorata laterale, anche con tamponamento in PVC. Opzionale.

- *Optional decorated side beam, which is also available with a PVC fabric valance.*



TENDE LATERALI IN ACRILICO ACRYLIC FABRIC SIDE CURTAINS

Possibilità di inserire tende laterali in acrilico, complete di cerniera di chiusura.

- *Side curtains are available in acrylic fabric with zipper closures and a fastening system along the pillars.*





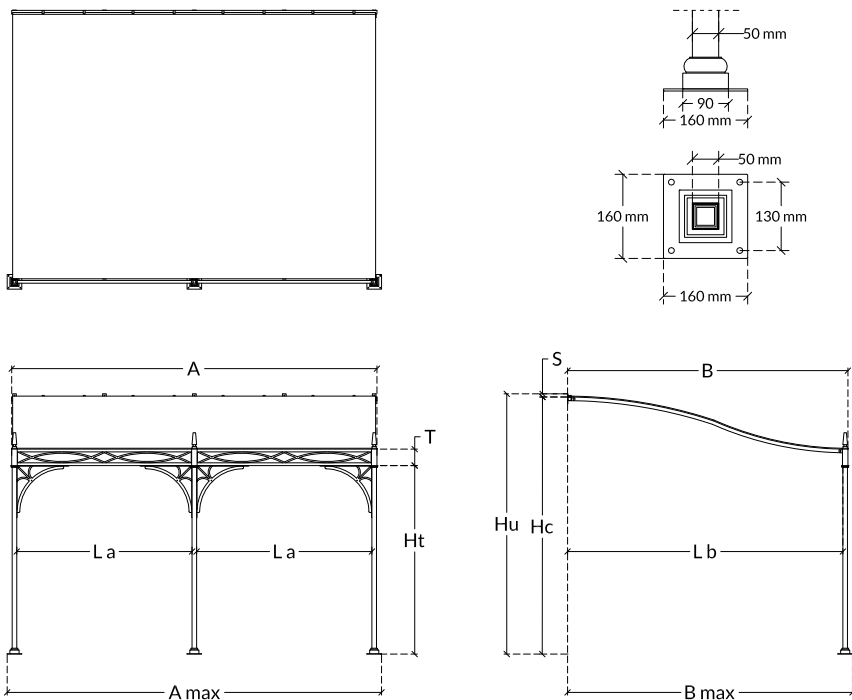

MISURE STANDARD STANDARD MEASURES

cm	da from 300x250	formati intermedi intermediate sizes	a to 400x500*
A	300	AxB	400
B	250	300x300	500
La	142	300x350	192
Lb	244,5	300x400	494,5
Amax	310	300x500*	410
Bmax	255	350x250	505
T	18	350x300	18
Ht	206	350x350	206
S	4	350x400	4
Hc	270	350x500*	334
Hu	274	400x250	330
		400x300	
		400x350	
		400x400	
		dettaglio di tutte le misure consultabile a listino details of all the measures available in the price list	

INFORMAZIONI TECNICHE TECHNICAL INFORMATION

- sezione pilastro 50x50x1,5 mm
 - sezione trave 180x30 mm sp 1,5 mm
 - sezione spioventi 40x30x2 mm
 - dimensione massima 400x500 cm
 - possibilità di realizzazione su misura
 - profili in acciaio lavorato con trattamento di zincatura a caldo
 - verniciatura a polveri epossidiche a base di resina poliestere, resistente ai raggi UV
 - possibilità di personalizzazione della verniciatura (con riferimento alla cartella colori RAL) previa approvazione dell'ufficio tecnico
 - telo di copertura standard in PVC PRECONTRAI NT 602, termosaldato, ignifugo classe 2/UNI9177, in colore champagne o bianco
- pillar section 50x50x1,5 mm
 - beam section 180x30 mm thickness 1,5 mm
 - sloping beam section 40x30x2 mm
 - maximum size 400x500 cm
 - customized available
 - steel profiles worked with hot dip galvanizing treatment
 - epoxy powder coating resin polyester, UV-resistant
 - customized powder coating available in other RAL color on request (prior approval of the technical office)
 - standard awning in PVC PRECONTRAI NT 602, sealed, flame retardant class 2/UNI9177, in champagne or white color
- * i modelli standard 300x500, 350x500 e 400x500 cm differiscono per la dimensione degli spioventi (60x30x3mm)
- * the 300x500, 350x500 e 400x500 cm standard model differs by the size of the sloping beams (60x30x3mm)

OPZIONI COLORE COLOUR OPTION

Struttura Structure:

Colore standard standard colour

antracite anthracite

Disponibile su quotazione
Available on quotations

tortora taupe

ruggine rust

sabbia sand

bianco 9010 9010 white

bianco 1013 1013 white

bianco opaco matt white

Telo di copertura Awning colours:

Tessuto standard standard fabric

PVC Preconstraint 602

champagne champagne

bianco white

Altre tipologie e colorazioni di tessuto
visionabili a pag 144

Other types and colour of fabric at page 144

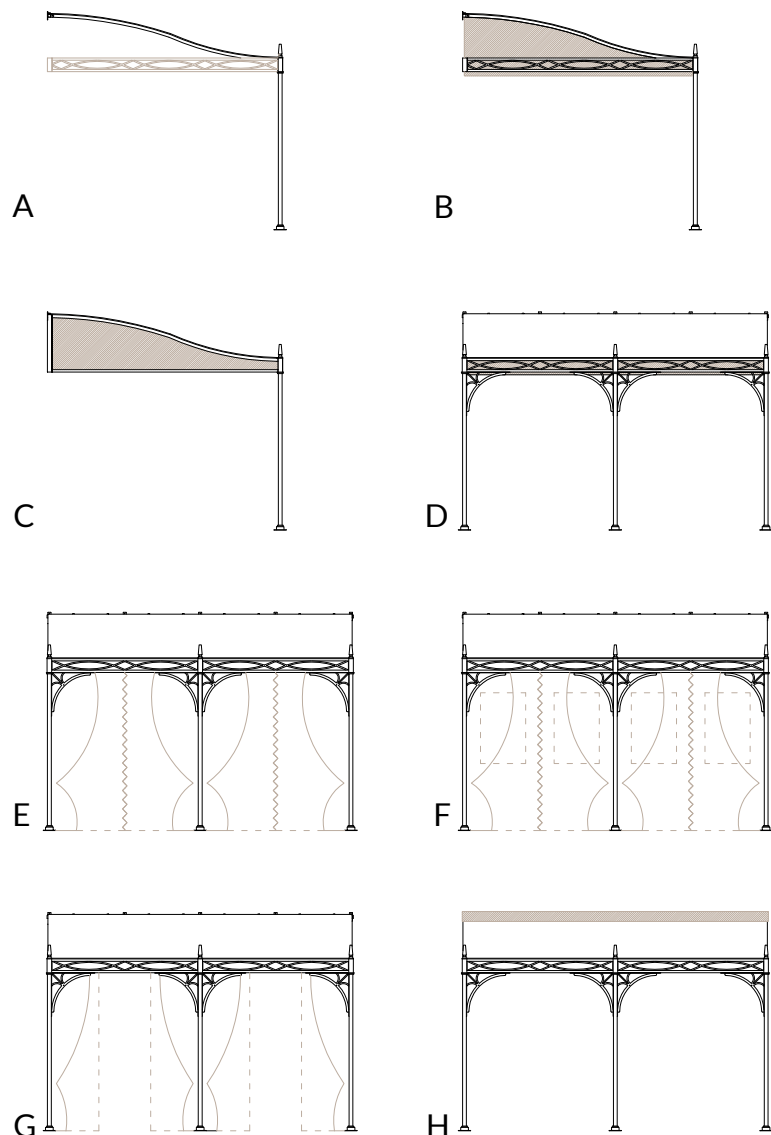

ACCESSORI OPTIONALI

- | | |
|--|--|
| <p>A
trave laterale con decoro disponibile nei colori della struttura</p> <p>B
trave laterale con decoro completo di tamponamento in PVC</p> <p>C
trave laterale semplice completo di tamponamento in PVC</p> <p>D
mantovana in tessuto PVC per il trave frontale</p> <p>E
tende laterali in tessuto acrilico Progar o in PVC con cerniera di chiusura e strisce in Velcro per il fissaggio alle colonne</p> <p>F
tende laterali in PVC con cerniera di chiusura e strisce in Velcro per il fissaggio alle colonne, con finestrate personalizzate in PVC Cristal</p> <p>G
tende ornamentali in acrilico Progar per decorazione della struttura</p> <p>H
scossalina di protezione in lamiera o rame per impedire le infiltrazioni di acqua piovana tra muro e pergola</p> | <p>A
<i>decorated side beam, available in the structure colors</i></p> <p>B
<i>decorated side beam complete with valance in pvc</i></p> <p>C
<i>simple side beam complete with valance in pvc</i></p> <p>D
<i>valance in PVC fabric, installed in the front beam</i></p> <p>E
<i>side curtains in acrylic Progar fabric or PVC with zipper closure, and Velcro strips for attaching to the columns</i></p> <p>F
<i>side curtains in PVC fabric with zipper closure, and Velcro strips for attaching to the columns, with personalized windows in PVC Cristal fabric</i></p> <p>G
<i>decorative curtains in Progar acrylic fabric for decoration facilities</i></p> <p>H
<i>protection flashings of sheet metal or copper to prevent the infiltration of rainwater between wall and pergola</i></p> |
|--|--|

GAZEBO E PERGOLE Opzioni colore *Colour option*



Struttura *Structure*
verniciatura elettrostatica a polvere di poliestere

antracite
anthracite



ruggine
russet



tortora
taupe



sabbia
sand



bianco 1013
white 1013



bianco 9010
white

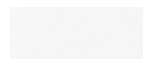

bianco opaco
matt white

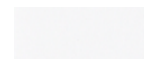

Telo di copertura *Awning colors*

PVC PRECONTRAI NT 602

impermeabile *waterproof fabric*
peso *weight* 590 g/m²
altezza *widht* 180 cm

reazione al fuoco *fire rating* M2/NFP92-507
B1/DIN 4102-1
CLASSE 2/UNI9177

resistenza alla temperatura *resistance to temperatures* +70°/-30°
riciclabile *recyclable*
garanzia anni *warranty years* 5

bianco
white

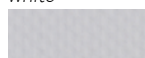

GTOT 0,09

champagne
champagne

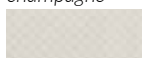

GTOT 0,08

PVC PRECONTRAI NT 502

impermeabile *waterproof fabric*
peso *weight* 750 g/m²
altezza *widht* 267 cm

reazione al fuoco *fire rating* M2/NFP92-507
B1/DIN 4102-1
CLASSE 2/UNI9177

resistenza alla temperatura *resistance to temperatures* +70°/-30°
riciclabile *recyclable*
garanzia anni *warranty years* 5

beige sabbaiato
sand beige

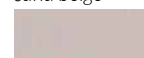

GTOT 0,09

pepe
pepe



GTOT 0,07

ciottolo
pebble



GTOT 0,07

PVC STAM

impermeabile *waterproof fabric*
peso *weight* 630 g/m²
altezza *widht* 260 cm

reazione al fuoco *fire rating* M2/NFP92-507
B1/DIN 4102-1
CLASSE 2/UNI9177

resistenza alla temperatura *resistance to temperatures* +70°/-30°
riciclabile *recyclable*
garanzia anni *warranty years* 5

bianco
white



GTOT 0,08

tortora
taupe



GTOT 0,09

antracite
anthracite



GTOT 0,08

ciottolo
pebble



GTOT 0,06

vaniglia
vanilla



GTOT 0,07

PVC OPATEX

impermeabile *waterproof fabric*
peso *weight* 850 g/m²
altezza *widht* 300 cm

reazione al fuoco *fire rating* M2/NFP92-507
B1/DIN 4102-1
CLASSE 2/UNI9177

resistenza alla temperatura *resistance to temperatures* +70°/-30°
riciclabile *recyclable*
garanzia anni *warranty years* 5
oscurante *block out*

bianco
white



GTOT 0,02

champagne
champagne



GTOT 0,03

ACRILICO

idrorepellente antimuffa *water repellent anti-mould*
peso *weight* 290 g/m²
altezza *widht* 120 cm
riciclabile *recyclable*
garanzia anni *warranty years* 10

bianco
white



tortora
taupe





Tessuti tende *Fabrics for curtains*

ACRILICO PROGAR

idrorepellente antimuffa *water repellent anti-mould*
 peso *weight* 290 g/m²
 altezza *widht* 182cm

bianco
white



tortora
taupe



écru
écru



PVC PRECONTRAIINT 602

impermeabile *waterproof fabric*
 peso *weight* 590 g/m²
 altezza *widht* 180 cm
 reazione al fuoco *fire rating* M2/NFP92-507
 B1/DIN 4102-1
 CLASSE 2/UNI9177
 resistenza alla temperatura *resistance to temperatures* +70°/-30°
 riciclabile *recyclable*
 garanzia anni *warranty years* 5

bianco
white

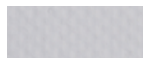

champagne
champagne

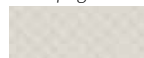

PVC PRECONTRAIINT 502

impermeabile *waterproof fabric*
 peso *weight* 750 g/m²
 altezza *widht* 267 cm
 reazione al fuoco *fire rating* M2/NFP92-507
 B1/DIN 4102-1
 CLASSE 2/UNI9177
 resistenza alla temperatura *resistance to temperatures* +70°/-30°
 riciclabile *recyclable*
 garanzia anni *warranty years* 5

beige sabbaiato
sand beige



pepe
pepe



GTOT 0,09

GTOT 0,07

ciottolo
pebble



GTOT 0,07

PVC CRISTAL

impermeabile *waterproof fabric*
 peso *weight* 610 g/m²
 altezza *widht* 132 cm
 reazione al fuoco *fire rating* M2/NFP92-507
 B1/DIN 4102-1
 CLASSE 2/UNI9177
 resistenza alla temperatura *resistance to temperatures* +60°/-10°

trasparente
transparent



GTOT 0,55